

# **MX4**

MULTI SYNTH

## **User Guide**

**MOTU**

---

1280 Massachusetts Avenue  
Cambridge, MA 02138  
Business voice: (617) 576-2760  
Business fax: (617) 576-3609  
Technical support: (617) 576-3066  
Tech support web: [www.motu.com/support](http://www.motu.com/support)  
Web site: [www.motu.com](http://www.motu.com)

## **About the Mark of the Unicorn License Agreement and Limited Warranty on Software**

TO PERSONS WHO PURCHASE OR USE THIS PRODUCT:

carefully read all the terms and conditions of the “click-wrap” license agreement presented to you when you install the software. Using the software or this documentation indicates your acceptance of the terms and conditions of that license agreement.

Mark of the Unicorn, Inc. (“MOTU”) owns both this program and its documentation. Both the program and the documentation are protected under applicable copyright, trademark, and trade-secret laws. Your right to use the program and the documentation are limited to the terms and conditions described in the license agreement.

### **Reminder of the terms of your MOTU software license**

This summary is not your license agreement, just a reminder of its terms. The actual license can be read and printed by running the installation program for the software. That license agreement is a contract, and clicking “Accept” binds you and MOTU to all its terms and conditions. In the event anything contained in this summary is incomplete or in conflict with the actual click-wrap license agreement, the terms of the click-wrap agreement prevail.

YOU MAY: (a) use the enclosed program on a single computer; (b) physically transfer the program from one computer to another provided that the program is used on only one computer at a time and that you remove any copies of the program from the computer from which the program is being transferred; (c) make copies of the program solely for backup purposes. You must reproduce and include the copyright notice on a label on any backup copy.

YOU MAY NOT: (a) distribute copies of the program or the documentation to others; (b) rent, lease or grant sublicenses or other rights to the program; (c) provide use of the program in a computer service business, network, time-sharing, multiple CPU or multiple user arrangement without the prior written consent of MOTU; (d) translate, adapt, reverse engineer, decompile, disassemble, or otherwise alter the program or related documentation without the prior written consent of MOTU.

MOTU warrants to the original licensee that the disk(s) on which the program is recorded be free from defects in materials and workmanship under normal use for a period of ninety (90) days from the date of purchase as evidenced by a copy of your receipt. If failure of the disk has resulted from accident, abuse or misapplication of the product, then MOTU shall have no responsibility to replace the disk(s) under this Limited Warranty.

THIS LIMITED WARRANTY AND RIGHT OF REPLACEMENT IS IN LIEU OF, AND YOU HEREBY WAIVE, ANY AND ALL OTHER WARRANTIES, BOTH EXPRESS AND IMPLIED, INCLUDING BUT NOT LIMITED TO WARRANTIES OF MERCHANTABILITY AND FITNESS FOR A PARTICULAR PURPOSE. THE LIABILITY OF MOTU PURSUANT TO THIS LIMITED WARRANTY SHALL BE LIMITED TO THE REPLACEMENT OF THE DEFECTIVE DISK(S), AND IN NO EVENT SHALL MOTU OR ITS SUPPLIERS, LICENSORS, OR AFFILIATES BE LIABLE FOR INCIDENTAL OR CONSEQUENTIAL DAMAGES, INCLUDING BUT NOT LIMITED TO LOSS OF USE, LOSS OF PROFITS, LOSS OF DATA OR DATA BEING RENDERED INACCURATE, OR LOSSES SUSTAINED BY THIRD PARTIES EVEN IF MOTU HAS BEEN ADVISED OF THE POSSIBILITY OF SUCH DAMAGES. THIS WARRANTY GIVES YOU SPECIFIC LEGAL RIGHTS WHICH MAY VARY FROM STATE TO STATE. SOME STATES DO NOT ALLOW THE LIMITATION OR EXCLUSION OF LIABILITY FOR CONSEQUENTIAL DAMAGES, SO THE ABOVE LIMITATION MAY NOT APPLY TO YOU.

### **Update Policy**

In order to be eligible to obtain updates of the program, you must complete and return to MOTU the MOTU Purchaser Registration Card found at the beginning of the MX4 User Guide or register on line at [www.motu.com/registration](http://www.motu.com/registration).

### **Copyright Notice**

Copyright © 2015, 2014, 2013, 2012, 2011, 2010, 2009, 2008, 2007, 2006, 2005, 2004 by Mark of the Unicorn, Inc. All rights reserved. No part of this publication may be reproduced, transmitted, transcribed, stored in a retrieval system, or translated into any human or computer language, in any form or by any means whatsoever, without express written permission of Mark of the Unicorn, Inc., 1280 Massachusetts Avenue, Cambridge, MA, 02138, U.S.A.

Digital Performer, MOTU, Mark of the Unicorn and the unicorn silhouette logo are trademarks of Mark of the Unicorn, Inc.

All other trademarks are property of their respective owners.

# Contents

5	<b>About MX4</b>
9	<b>MX4 Quick Reference</b>
11	<b>QuickStart Guide</b>
13	<b>MX4 Tutorial</b>
19	<b>The MX4 Window</b>
53	<b>Five Things You Should Know About MX4</b>
55	<b>Troubleshooting</b>
61	<b>Glossary</b>
65	<b>NRPN Mapping</b>

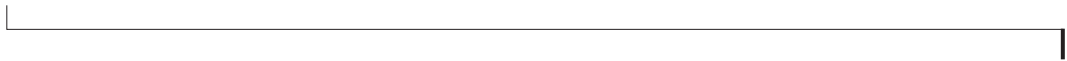

## CHAPTER 1 **About MX4**

MX4 is a virtual instrument plug-in that features a unique, hybrid synthesis engine that combines several forms of synthesis, including subtractive, wavetable, frequency modulation (FM), amplitude modulation (AM) and analog emulation. MX4's flexible programming and advanced modulation architecture provide the intimacy of a vintage synth, the flexibility of a modular synth, and the innovation of a virtual synth.

### **Born from synth legends**

Our inspiration for MX4 came from legendary subtractive synthesizers like the Prophet-5, PPG Wave and Moog Modular, but then we took the concept further using today's powerful computer software technology. The result is a unique, hybrid synthesis engine that delivers both fresh and vintage synth sounds alike. Fat basses, nasty leads, analog pads, vintage electronica — it's all at your fingertips and conveniently saved with your Digital Performer projects for instant recall. Whether you're looking for killer synth presets or intense synth programming, MX4 is for you.

### **A flexible and convenient plug-in**

You can employ MX4 as a flexible, state-of-the-art sound source directly within your projects and then save all MX4 settings with the project for instant and total recall. Since all MX4 settings are saved with your Digital Performer session, you enjoy the highest degree of convenience and speed because there is no separate application or associated documents to manage.

Tweaking sounds is fast and easy with clearly presented controls in one window — but with a depth and sophistication true synth programmers will appreciate.

### **Professional performance**

MX4 operates efficiently and provides unlimited voices and instantiations (subject to the processing resources of the host computer). Playback is sample-accurate. MX4's 32-bit internal resolution provides wide dynamic range, and it supports all standard sample rates up to 192kHz. You can work fast and intuitively in a single, efficiently organized window labeled with real-world values like semitones, decibels, etc. All settings are saved with your Digital Performer projects for instant recall.

### **A flexible, hybrid synthesis engine**

MX4's basic synthesis architecture provides three oscillators with modulatable waveform symmetry and hard sync, two variable topology multimode filters, six variable waveshape LFO's and four ADSHR envelopes.

### **Oscillators**

MX4 provides all standard analog synthesizer waveforms, but every waveform has adjustable symmetry. This allows you to create standard pulse width modulation effects, as well as waveform “morphing” effects, such as smoothly changing from a triangle waveform to a sawtooth. Changing the symmetry of simple sine waves can even create interesting and unique spectra.

Each of the three oscillators can use a wavetable instead of a standard waveform. Dozens of wavetables are supplied, in two forms (*classic* and *anti-aliased*) that give you the best of both worlds: classic wavetables that are perfect for that sought-after, searing aliasing effect and anti-aliased wavetables that give you pure, pristine sound, even in the highest registers. The wavetable on each

oscillator can be individually indexed, and symmetry can be applied to wavetables as well, for a wide array of timbres.

Oscillators 1 and 2 can be synced together to create the same hard sync effects found on classic analog polysynths such as the Sequential Circuits Prophet-5 and Moog Memorymoog.

Oscillator 3 serves as a frequency modulation (FM) source for other oscillators — or the filter cutoff frequency. Because oscillator 3 includes all waveforms, as well as the wavetable and symmetry features found on the other oscillators, it can produce a wide array of modulation effects that extend from LFO rates into the audible range.

In addition to the three oscillators, an independent fundamental-tone oscillator and ring modulator are also included to further extend the oscillator section.

### **Filters**

Two resonant multimode filters (with modulatable overdrive) provide low-pass, high-pass, band-pass and notch filters with independent slope specified as 6, 12, 18 or 24dB per octave for a total of 16 different filter types. As a result, you can create a wide variety of vintage keyboard sounds. Both filters can also be stacked, combining them for a total of 48dB per octave.

MX4's unique Variable Filter Topology™ allows you to easily and intuitively arrange the two filters and overdrive (distortion) unit in 14 different configurations that produce over 3,000 different filter topologies. You can then further adjust the filter settings, providing a very wide range of filter effects to explore.

### **Modulation architecture**

The six variable waveshape LFOs include adjustable symmetry, rate delay, fade and phase. Four ADSHR envelopes are also provided, with graphic controls for intuitive programming. All parameters can be modulated.

### **Fully programmable modulation matrix**

Flexible modulation routings are essential for expanding the sonic palette of a subtractive synthesizer such as MX4. All continuously variable parameters, including LFO's and envelopes, can be modulated by many sources, including track automation, MIDI controllers, LFO's and envelopes. They can even be modulated by multiple sources simultaneously.

Conversely, each modulation source in MX4 can modulate an unlimited number of destinations simultaneously, with the modulation range independently scaled at each destination. This provides modulation flexibility rarely seen outside of a modular synthesizer - but without the associated complexity. You can point at a modulation source, and MX4 highlights all of the parameters it is modulating. The filters and envelopes display the modulation range both on the knob itself and on the graphical representation. Modulation routings are clearly displayed in the MX4 window so you do not have to search through multiple pages or windows.

### **Programmable modulators**

Pulsating, rhythmic, hypnotic, groovetronic— these are just some of the words that can be used to describe the rhythm-based effects in MX4. MX4's *Mods* page represents an entirely new dimension in multi-synth programming. You now have unprecedented control over the sounds you can sculpt and design in MX4, all just a click away.

*Pattern gate* — slices MX4’s synth section into programmable pulses that are tempo-locked to Digital Performer’s time line. Control pulse shape, pattern, length and swing.

*Arpeggiator* — gives you everything you need to quickly achieve the arpeggiator effect you are looking for, including the *as played* setting, which lets you control the order in which every note is played. Or go “hands off” with the hold feature, which continues to play the arpeggio even after you let go of the keys.

*Trigger sequencer* — triggers an MX4 envelope rhythmically with Digital Performer’s tempo. Program any pattern you wish.

*Gate and effects topology* — lets you graphically arrange the signal flow of the synth section through MX4’s two effects modules and the pattern gate. It’s as simple as clicking and dragging.

*Enhanced modifier key shortcuts* — MX4 provides an innovative, “hands-on” approach to programming modulation sources and destinations by clicking directly on the controls in the window with several intuitive modifier key shortcuts. The manipulation is so direct, you’ll feel like you are touching the sound itself.

*Pattern sequencer* — gives you the means to rhythmically modulate just about any parameter in MX4, with pin-point control over every step of the pattern. Sure, you can apply it to oscillator pitch, but that’s just the beginning. The Pattern Sequencer can be applied to any continuously modulateable parameter, like filters, effects parameters, wavetable index—you name it. This feature alone provides a entire universe of possibilities to explore.

*Envelope follower* — brings the outside world into MX4 by transforming the amplitude of any external audio signal into a control signal for use

inside MX4, as either a modulation source or shaper. Guitar FX and filter FX are examples to get your ideas flowing, but MX4’s modulation architecture is so flexible, you’ll quickly discover entirely unique ways to dynamically interact with MX4’s multi-synth engine.

### **Shapers**

Modulation sources can be fine-tuned and sculpted using shapers, a secondary modulation phase that applies directly to the modulator. MX4 ships with dozens of shapers, including Invert, Transform, Sample & Hold, Lag Processor and Quantizer. These shapers can mean the difference between making a sound great to your ears and making it perfect.

### **Intelligent preset management**

Another critical feature you need from a virtual instrument is easy access to your sounds. MX4™ offers convenient, easy-access preset management, helping you concentrate on your music — not preset handling chores. MX4 includes hundreds of presets organized into convenient banks. Quickly zero in on the sound you’re looking for, and then tweak it to perfection as your music plays.

### **Support for 24-bit 192kHz audio**

MX4 takes advantage of high definition audio interfaces like the MOTU HD192, allowing you to play your music at any sample rate up to 192kHz.

### **Integrated effects**

Built-in chorus, flanger, phaser, reverb, and delay integrate with MX4 throughout its entire modulation architecture to add unprecedented variety, depth and complexity to your sounds. Modulate effect parameters — and then save the effects — as part of the patch. All effects settings are saved with each preset for total recall.

### **External audio input**

Process any audio through MX4's synthesizer architecture. Use the FM filter effects, note triggering and effects. With its oscillators, filters, envelopes, LFOs, and flexible modulation, MX4 will become one of the most powerful effects processors in your arsenal.

### **Hundreds of factory presets**

MX4 provides hundreds of factory presets, many of which take full advantage of MX4's deep programming features, such as the pattern gate, arpeggiator and pattern sequencer. Be sure to explore the presets, as they serve as a great point of departure for programming many new and unique sounds of your own.



# MX4 Quick Reference



Presets are organized into banks. Use the +/- buttons to browse the lists in the menus.

The LCD display shows the name of the current parameter you are adjusting, along with its current value.

Choose a preset from the patch menu, or use the +/- buttons to browse the presets in the current bank.

Saves changes you've made to a preset, or compare/revert back to the original.

These four buttons act like tabs, flipping the MX4 window among different pages of controls: the main controls (shown here), mods (modulators), file (management) and random (ization of parameters).

Blinks when MX4 receives MIDI data.

Collapses the window to a compact strip.

If the parameter is being modulated, the source and range are shown here.

Dynamically updates to show the number of voices currently playing.

MX4 provides three wavetable oscillators with adjustable waveform symmetry. Click the oscillator number to enable/disable it. Choose the desired waveform from the menu.

To enable one or both filters, with or without the distortion module, choose the desired filter configuration from the topology menu.

The mixer section controls the mix of the fundamental, ring modulation external audio input and stereo panning for the oscillators during stereo operation.

Access the settings for each of the four envelopes with these buttons. The six-stage DADSHR envelopes can be used as a modulation source for any modulatable parameter.

Click this button to select the modulation source. Then option-drag any continuously variable parameter to control it with this source.

Use the disclosure triangle (at far right) to display the effects section with chorus, phaser, flanger, delay and reverb.

Access the six LFOs with these buttons.

The master section provides global settings.

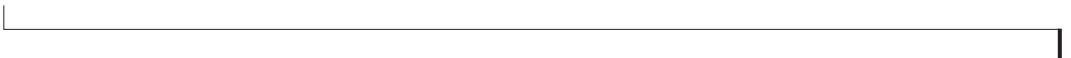

## CHAPTER 2 QuickStart Guide

### Open MX4

1 Launch Digital Performer.

2 Open MX4 in the standard fashion for instrument plug-ins. For details, see chapter 16, “Instrument Tracks” (page 141) in the *DP User Guide*.

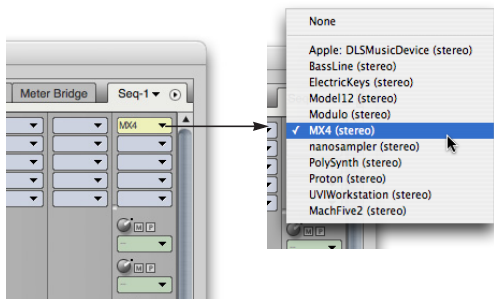

Figure 2-1: Opening MX4 in Digital Performer.

3 Create a MIDI track in the usual fashion and assign it to MX4’s MIDI input (labeled *MX4-1-in* as demonstrated below in Figure 2-2; *MX4-1* is the track name for the MX4 instrument track.)

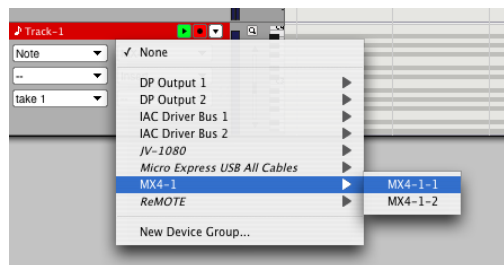

Figure 2-2: Assigning the output of a MIDI track in Digital Performer to MX4.

4 Set up patch thru from your MIDI controller in the usual fashion (record-enable the MIDI track to begin playing MX4 from your controller).

5 Choose a bank and preset in the MX4 window.

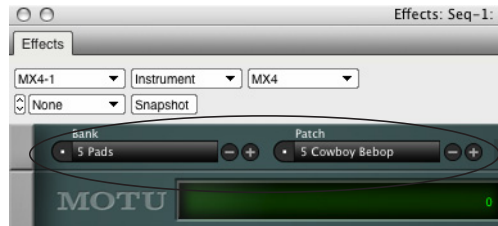

Figure 2-3: Choosing a bank and preset.

6 That’s it! You are ready to experiment with MX4.



# CHAPTER 3 MX4 Tutorial

## OVERVIEW

This brief tour of MX4 will show you how easy it is to program your own MX4 presets.

- Load the tutorial preset ..... 13
- Enable an oscillator ..... 13
- Adjust a parameter ..... 13
- Modulate OSC1 symmetry ..... 14
- Contextual menus ..... 14
- Use a wavetable ..... 15
- Apply multiple modulation sources ..... 16
- Enable a filter ..... 16
- Add a second filter ..... 17
- Mixing and effects ..... 18
- Congratulations! ..... 18

## LOAD THE TUTORIAL PRESET

**1** Choose the *Tutorial Patches* bank and the *Movie Demo* patch.



## ENABLE AN OSCILLATOR

**2** Confirm that oscillator 1 is enabled. The number “1” is green when it is enabled. If it is white, click the “1” button to enable oscillator 1.



**3** Hold down middle C on your MIDI controller to play the preset.

You should hear a plain square wave sound. If not, check your MIDI and audio connections. If you still don't hear anything, be sure you've set up Digital Performer as described in chapter 2, “QuickStart Guide” (page 11).

## ADJUST A PARAMETER

**4** Adjust the course pitch of the oscillator.

While holding down middle C on your keyboard, move the pitch slider back and forth. This lets you control the base pitch of the oscillator. Course adjustment is made in semitones.

**5** Notice that the LCD displays your course pitch adjustments.



**6** Fine-tune the pitch of the oscillator.

To do so, hold down the command key while dragging the slider. If you can manage to hold down both the command key on your computer keyboard and middle C on your MIDI controller at the same time, you'll hear the pitch bend as you drag the slider.

**7** Return the pitch slider to zero by double-clicking the slider handle.

8 Adjust the symmetry of the square wave by moving the symmetry slider.

With a square wave, adjusting the symmetry slider produces pulse width modulation effects. Try moving the slider as you once again hold down middle C on your controller.

### MODULATE OSC1 SYMMETRY

Modulate oscillator 1's symmetry slider with LFO 2.

9 Click the button next to LFO 2 in the modulation Source section, as shown below:

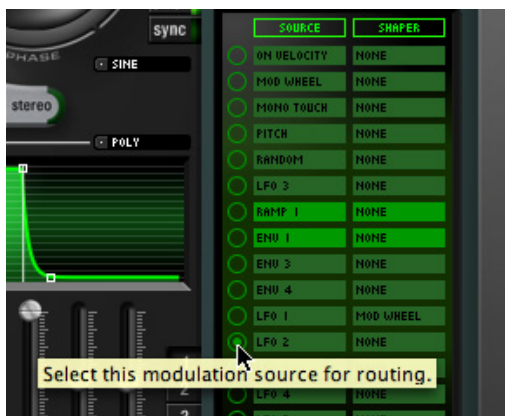

10 Option-drag oscillator 1's symmetry slider to create the modulation range.

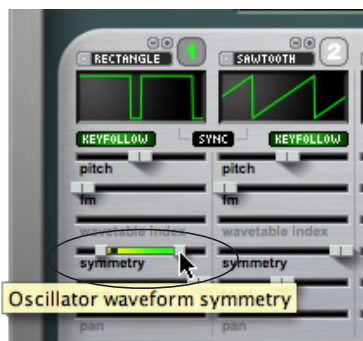

Notice that as you drag, the handle splits in two over a highlighted (green) range. This indicates that the parameter is being modulated over this range. Notice also that if you position the cursor over the symmetry slider, the LFO 2 modulation source highlights in the Source section:

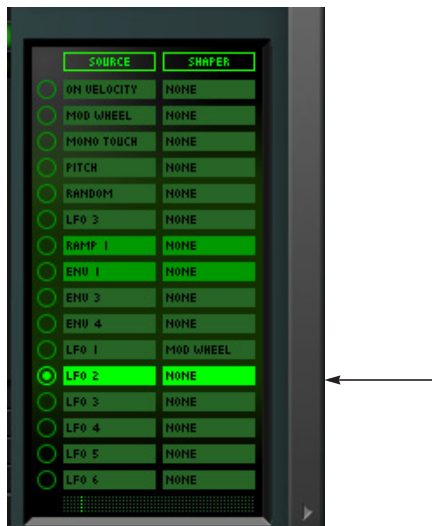

In addition, the LCD displays the modulation source and range on the right-hand side:



11 Hold down middle C to audition the pulse width modulation you've just created.

### CONTEXTUAL MENUS

If you change your mind, you can easily disconnect a modulation source. Let's try it. To do so, control-click on the symmetry slider to open a contextual menu for the slider. This menu provides many additional operations for the symmetry parameter.

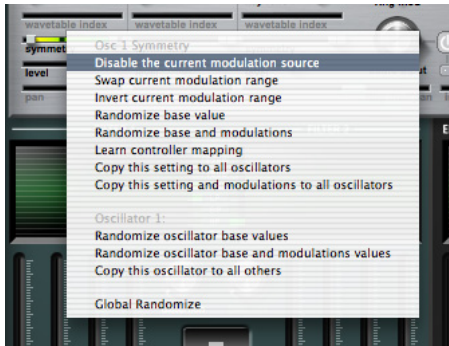

Figure 3-1: An example for a contextual menu. In this example, the menu is for oscillator 1's symmetry parameter. To see this menu for any parameter, control-click it.

**12** Choose **Disable the current modulation source**.

This disconnects LFO 2 from the symmetry parameter so that it is no longer being modulated by LFO 2.

### USE A WAVETABLE

Now let's change oscillator 1 from a square wave to a wavetable.

**13** Click on the word *rectangle* at the top of the oscillator 1 section to open a menu of other waveform choices for the oscillator:

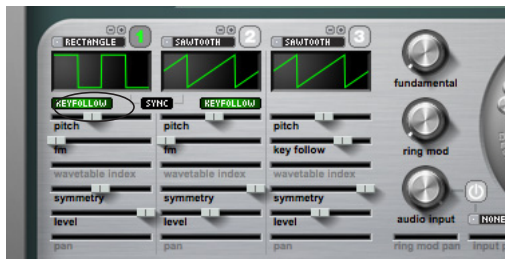

**14** Choose *Wavetable* from the menu, and choose *Sufi 9* from the sub-menu.



Figure 3-2: Choosing a wavetable for oscillator 1.

**15** Hold down middle C to audition the wavetable.

Now let's try adjusting the wavetable index.

**16** While holding down middle C, drag the wavetable index slider left and right.

**17** Return the wavetable index to zero by double-clicking it.

Let's use an envelope to modulate the wavetable index for us.

**18** Choose envelope 3 (*env 3*) in the *Source* section.

**19** Option-drag oscillator 1's wavetable index slider about half way to the right (so the range ends approximately in the middle):

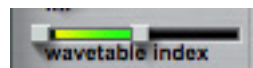

**20** Audition the change by playing middle C again.

**21** You can still adjust the index parameter, even when it has a modulation range. Let's try it. Drag the entire modulation range to the right to adjust the index range. Audition the result by playing middle C.

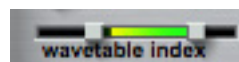

## APPLY MULTIPLE MODULATION SOURCES

This envelope modulation is a good start, but the preset could use a bit more modulation to be more interesting as a sound. Let's add some LFO modulation as well.

**22** Choose LFO 2 in the *Source* section.

**23** Option-drag the wavetable index slider to apply a modulation range for LFO 2.

☞ Don't worry if you see red numbers in the LCD when you option-drag. This just means that the modulation range you've specified is out of range, so that the LFO will peg at one end of the range and/or the other. But no harm is done. To bring it back within range, option-drag back the other way until the numbers turn green again.

**24** Audition the result.

The wavetable index parameter now has two modulation sources operating on it.

**25** To confirm this, roll the cursor over the slider (without clicking).

As you do so, both modulation sources light up in the *Source* section:

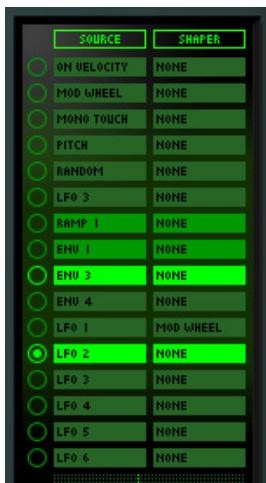

Now let's add some symmetry modulation for a little extra motion.

**26** Choose LFO 3 in the *Source* section.

**27** Option-drag oscillator 1's symmetry slider.

**28** Audition the result.

## ENABLE A FILTER

Now let's enable a filter.

**29** Choose the filter configuration shown below from the filter *Topology* menu.

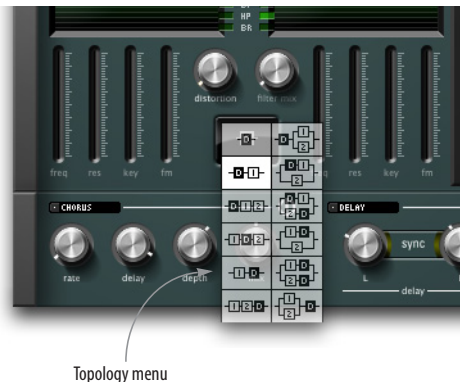

**30** Confirm that the *LP* (lowpass) and *24* (24dB slope) lights are illuminated for Filter 1, as shown above.

**31** Open the filter by increasing the cutoff frequency.

**32** Hold down middle C as you drag the cutoff frequency slider up and down to audition the effect.





**33** Move the resonance (*res*) slider up to add a little resonance.

Now let's modulate the filter cutoff frequency with an envelope.

**34** Choose envelope 4 (*env 4*) in the *Source* section.

**35** Option-drag Filter 1's cutoff frequency (*freq*) slider.

Because the modulation range is above the base value, the envelope is being applied inverted. We can swap the modulation range by using the cutoff frequency's contextual menu.

**36** Control-click Filter 1's *freq* slider and choose *Swap current modulation range* from the menu.

**37** Audition the result.

Notice that the filter closes down as you hold the note, rather than opening up, as it did before.

Now let's try using MIDI note-on velocity to control the attack of envelope 4.

**38** Choose *On Velocity* in the *Source* section.

**39** Choose Envelope 4 by clicking its button, as shown below:

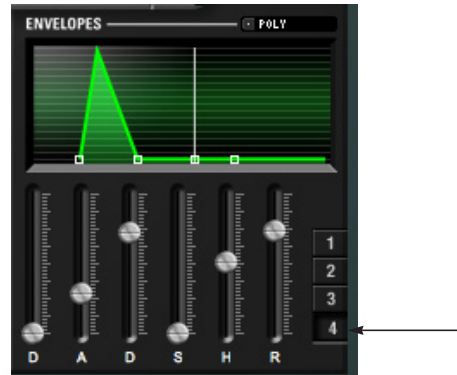

**40** Option-drag the envelope Attack slider (labeled *A*) to assign the on-velocity modulation range.

**41** Audition the result, striking your MIDI controller key with varying strength.

Notice that when you now strike the key softly, the envelope opens more slowly; when you strike the key harder, the envelope opens more quickly.

## ADD A SECOND FILTER

Now let's add Filter 2 for additional complexity. We'll add it as a highpass filter in parallel with Filter 1.

**42** Choose the parallel setting from the Topology menu as shown below.



**43** Confirm that Filter two is a highpass (*hp*) filter with 24 dB slope (24).

**44** Use the Filter Mix knob to adjust the mix of the two filters, playing a note on your MIDI controller while you turn the knob to audition the effect.

Turning the knob all the way counter clockwise gives you 100% of Filter 1 and 0% Filter 2. Turning the knob all the way clockwise gives you the opposite (100% Filter 2 and 0% Filter 1). Settings in the middle provide a mix of both filters.

Now let's modulate the filter mix with MIDI note-on velocity, so that the mix changes depending on how hard you strike the key.

**45** Confirm that *On Velocity* is still chosen in the modulation Source section.

**46** Option-drag the Filter Mix knob to apply the on-velocity modulation range.

**47** Control-click the Filter Mix knob and choose *Swap current modulation range*.

Now, the harder you hit your MIDI keys, the more filter 1 you hear. The more lightly you play, the more filter 2 you hear.

## MIXING AND EFFECTS

Let's finish the preset by mixing in some of the fundamental and adding some chorus and delay effects processing.

**48** Turn the *Fundamental* knob to the 2 o'clock position (a setting of approximately 0.75).

**49** Click the disclosure triangle to open the Effects section.



**50** Click the “Power” buttons for the Chorus and Delay to enable them. When enabled, the power buttons turn green.



## CONGRATULATIONS!

You've just created your first MX4 preset. Try playing it in a variety of octaves on your MIDI controller, as it takes on a unique character at the low, mid and high ranges of the keyboard.

# CHAPTER 4 The MX4 Window

## OVERVIEW

The MX4 window is comprised of 10 sections, as shown below in Figure 4-1. This chapter covers each section in detail.

- The disclosure buttons ..... 20
- Presets ..... 21
- File ..... 22
- Master section ..... 23
- Status ..... 26
- Oscillators ..... 26
- Filters ..... 31
- Envelopes ..... 33
- LFOs ..... 34
- Modulation ..... 36
- Mods ..... 40
- Mixer ..... 46
- Effects ..... 47
- Random ..... 49
- Modifier key shortcuts ..... 51
- Contextual menus ..... 51

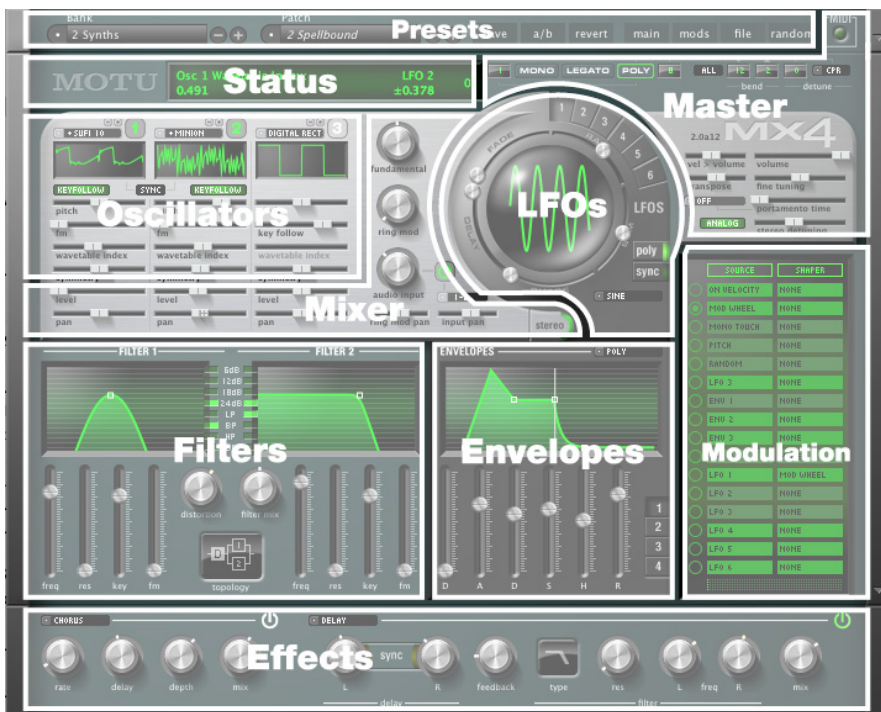

Figure 4-1: The MX4 window.

## THE DISCLOSURE BUTTONS

Click the disclosure buttons to show and hide sections of the MX4 window, as demonstrated below in Figure 4-2. When the window is fully

collapsed, it displays only the most essential controls (such as preset selection, preset compare/save, and MIDI activity) in a compact, screen-efficient strip.



Figure 4-2: The Expand buttons.

## PRESETS

A *preset* is a snapshot of all the settings in the MX4 window. MX4 ships with hundreds of useful presets organized by category in several dozen banks, such as *Synths*, *Leads*, *Strings*, etc. The Presets section at the top of the MX4 window (Figure 4-3) lets you choose, modify, save, compare and otherwise manage presets. MX4 can support an unlimited number of presets.

### Bank

A bank can hold up to 128 presets. When you choose a bank, its patches (presets) are displayed in the Patch menu. Use the +/- buttons next to the menu to choose the next or previous bank in the list. To create, rename or delete banks, see “File” on page 22.

### Patch

The Patch menu displays all of the presets in the bank currently chosen in the Bank menu. When you choose a preset from the menu, its settings are loaded into the MX4 window. Use the +/- buttons next to the menu to choose the next or previous preset in the list. Hold down the option key while clicking the +/- buttons to stay within the current bank when browsing presets. To create, rename, move, duplicate or delete patches, see “File” on page 22.

### Save

When you first choose a patch, the *Save* button is not available. As soon as you change any parameter in the MX4 window, *Save* becomes active, and the patch name becomes italic in the Patch menu to indicate that the patch has been modified. Click *Save* to store the changes you made to the patch (replacing the original version). If you wish to “save as” in order to preserve the original patch, see “File” on page 22.

### a/b

When you first choose a patch, the *a/b* button is not available. As soon as you change any parameter in the MX4 window, *a/b* becomes active, and the patch name becomes italic in the Patch menu to indicate that the patch has been modified. Click the *a/b* button repeatedly to toggle between the original patch and the modified version. The original patch is indicated by non-italic text; the modified patch name is italic. Note that the modified patch gives you access to the *Save* and *Revert* buttons, which do not apply to the original patch (since it is already saved).

### Revert

When you first choose a patch, the *Revert* button is not available. As soon as you change any parameter in the MX4 window, *Revert* becomes active, and the patch name becomes italic in the Patch menu to indicate that the patch has been modified. Click the *Revert* button to permanently discard any changes you’ve made to the patch.



Figure 4-3: The Preset section.

## Main

Use the *Main* button to return to the main MX4 window shown in Figure 4-2 on page 20.

## Mods

Use the *Mods* button to switch to MX4's mods pane shown in Figure 4-24 on page 40. See “Mods” on page 40.

## File

Click the *File* button (Figure 4-3) to display patch and bank management controls in the MX4 window, as shown in Figure 4-4. See “File”, below.

## Random

Click the *Random* button to display controls in the MX4 window for randomizing patch parameters, as shown in Figure 4-42. See “Random” on page 49.

## FILE

The *File* controls let you manage MX4 banks and patches.

## Source

The *Source* section lets you choose the patch you wish to work with. Click *Delete* to get rid of the current source patch. Click *Save* to save any changes that have been made to the current source patch (such as any edits to the name, author or other patch text).

## Destination

The *Destination* controls let you move a patch or “save as” to a new location in any bank. The *Move to* button places the patch at the chosen destination location and also empties the patch's current location. The *Save to* button preserves the source patch and makes a copy of it, along with any changes that have been made, to the chosen

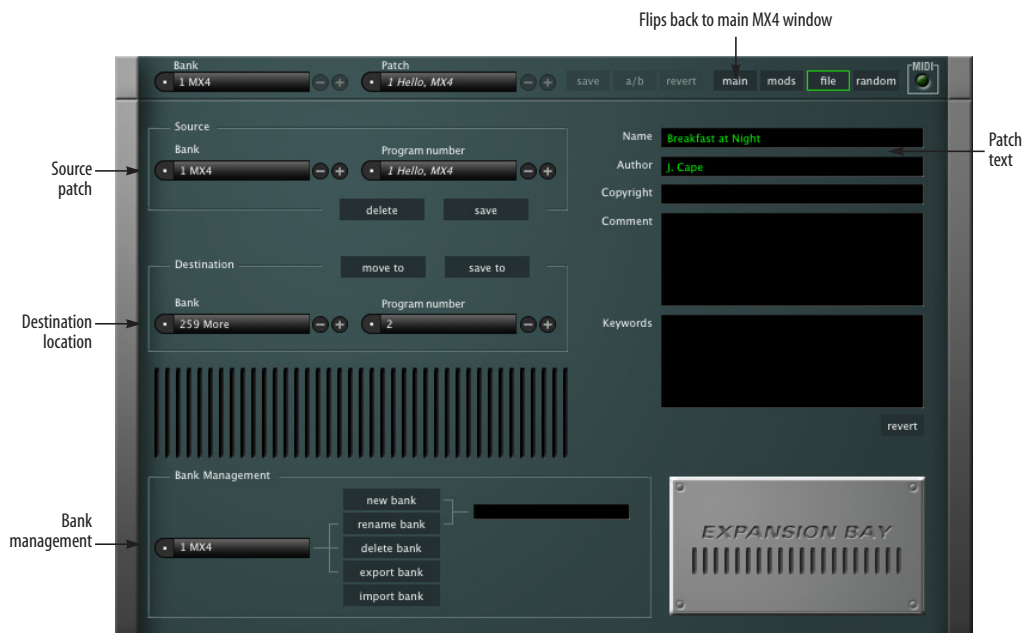

Figure 4-4: Click the File button to display the patch and bank management controls.

destination location. *Save to* is similar in concept to the standard *Save As* command in Digital Performer.

### Patch name, author, etc.

Edit the text in these text fields as desired. To save your changes, click the *Save* or *Save to* button (in the Source or Destination sections).

### New/rename/delete/export/import bank

Use these three buttons to manage banks as follows:

Goal	Action
To create a new bank	Type in a name in the text box on the right and click <i>New Bank</i> .
To rename a bank	Choose it from the menu, type in a new name in the text box on the right and click <i>Rename Bank</i> .
To delete a bank	Choose it from the menu and click <i>Delete Bank</i> .
To export a bank	Choose it from the menu and click <i>Export Bank</i> .
To import a bank	Click <i>import bank</i> and locate the desired bank file on your hard drive.

### Done

Click *Done* to return to the main MX4 window.

## MASTER SECTION

The Master section (Figure 4-5) provides global controls that affect the overall performance of the instance of MX4.

### MIDI activity light

The MIDI activity light blinks when MX4 receives MIDI data. This can be a useful troubleshooting tool. If MX4 is not making any sound when you play it, but the MIDI light does blink, then you can focus your troubleshooting efforts on the audio signal path.

### Mono/legato/poly modes

Just like classic analog synths, MX4 can operate in mono, legato or poly mode. Click the button shown in Figure 4-5 below to enable the desired mode.

In mono mode, only one note can be played at a time. Each new note will cut off the currently sustained note, if any.

Legato mode is an alternative form of mono mode where the envelope is not retriggered; only the pitch changes.

In poly mode, MX4 can play two or more notes simultaneously, up to the limit you type in next to the poly button. For example, if polyphony is set to 16, MX4 can play and sustain up to 16 notes at a time.

### Polyphony

The polyphony setting determines how many notes can play at a time. The maximum allowed polyphony for one instance of MX4 is 256. Beware, however, that higher polyphony settings place



Figure 4-5: The Master section.

higher demand on your host computer's processing resources. Therefore, the ideal polyphony setting is that which matches the highest number of notes you will actually need (the highest number of notes you will play simultaneously). Use the active voice display ("Active voices" on page 26) to determine how many voices a passage of music requires.

### Unison multiplier

The *unison multiplier* multiplies each note played. For example, if you set the unison multiplier to 2, each time you play a note, you'll actually be triggering two notes in unison. If the unison multiplier is set to 4, each note played actually triggers four unison notes. The unison multiplier can be used with all three modes (mono, legato or poly). The unison multiplier is good for thickening sounds, especially when used with the detune feature. See the section called "Detune" below.

 The unison multiplier is governed by the polyphony setting. For example, if the multiplier is set to 2 and you play one note, you are using 2 voices. So with a polyphony setting of 16, the maximum number of notes you can play in poly mode would be 8 (since each note is being doubled). In mono mode, MX4 automatically sets the polyphony for the multiplier.

### Bend

The bend parameters control how MX4 responds to pitch bend.

#### Bend mode

When *All* is chosen, pitch bend data bends all notes. When *Held* is chosen, MX4 only bends notes for which a note-off has not yet been received. Notes that have received a note-off but that are currently being sustained with a sustain pedal will not bend. Click the bend mode button to toggle between these two modes.

### Bend range

The pitch bend range is split at zero into two pitch bend ranges: *upper* and *lower*. The upper range determines how much pitch bend occurs between the zero position on your pitch bend wheel (or other controller) and its highest position. The lower setting determines the range from zero to the pitch bend wheel's lowest position. By setting them to different values, you can more easily bend up and down by different amounts.

The upper and lower pitch bend ranges offer a maximum range of four octaves (4800 cents) each, for a combined maximum of eight octaves.

### Detune

Detune allows you to determine how much pitch variation there will be on unison triggered notes. The amount of detune is specified in Hz or cents, depending on the detune mode you specify. MX4 provides three detune modes, discussed below.

#### None

Detune is turned off.

#### Constant beat frequency

*Constant beat frequency* allows you to express detune in hertz (Hz). The result is that the phasing ("beating") effect between the two slightly detuned unison pitches remains constant (it "beats" at the same rate) across the entire keyboard. In addition, detuning becomes more apparent as you move lower on the keyboard because the frequency offset becomes less perceptible at higher frequencies.

#### Constant pitch ratio

*Constant Pitch Ratio* (CPR) mode allows you to express detune in cents (100ths of a semitone). The result is that the amount of detune is relative to the frequency of the pitches being played. Higher notes produce higher frequency "beating" while lower notes produce slower "beating". Therefore, higher notes will likely be perceived as being more out of tune than lower notes. With lower notes, the effect



sounds more like an LFO. Be careful with when using Constant Pitch Ratio with higher amounts of detune because bass notes can become too far out of tune.

### Vel > Volume (Velocity sensitivity)

This setting controls the degree to which MIDI note-on velocity affects the amplitude of envelope 1. Higher values make sounds more responsive to how hard you play the keys on your controller; lower values make it less responsive. As demonstrated below (Figure 4-6), a setting of zero (0%) normalizes all note-on velocities to 64 (the middle of the velocity range), regardless of how hard you strike a key. A setting of 100% triggers the full amplitude range over the 0-127 MIDI velocity range. A setting of 50% limits the MIDI velocity range (0-127) to the middle portion of the amplitude range (from 25% to 75%).

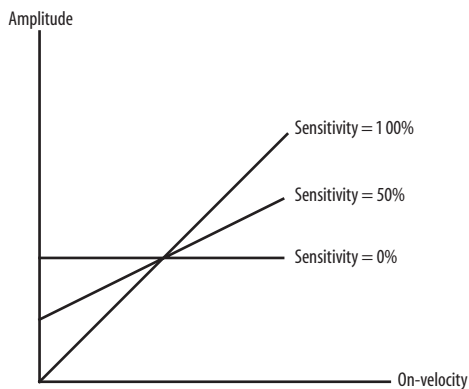

Figure 4-6: The effect of velocity sensitivity on sustain level.

### Volume

The *Volume* slider controls MX4's overall volume.

### Transpose (coarse tuning)

The *Transpose* setting transposes MX4 globally by the number of semitones that you specify. Use the command key to change the value in one-semitone increments.

### Fine tuning

The *Fine Tuning* setting transposes MX4 globally by the number of cents (100ths of a semitone) that you specify. Use the command key to change the value in one-cent increments.

### Portamento

*Portamento* is a continuous, smooth glide in pitch from one note to another. Use the slider to choose a value from zero (no portamento) to 100% (full portamento). MX4 offers three portamento modes, discussed below.

#### Off

Portamento is turned off.

#### Constant portamento time

When *Constant portamento time* is chosen, the length of time for the glide between notes is the same, regardless of the interval between pitches.

#### Constant portamento time per octave

When *Constant portamento time per octave* is chosen, the length of time for the glide between notes is determined by the interval between the two notes: the farther the interval, the longer the glide. Conversely, shorter intervals produce shorter (faster) glides.

### Stereo Detune

The *Stereo Detune* parameter is a stereo effect that is disabled when *Stereo mode* (see "Stereo mode" on page 46) is turned off. When *Stereo mode* is turned on, and *Stereo Detune* is adjusted to any value other than zero, a second oscillator is engaged for each of MX4's three oscillators, and each oscillator pair is then panned hard left and hard right. The result is a significant increase in the presence and stereo spread of the sound. Moving the slider to the right increases the pitch deviation to further enhance the effect.

👉 Tip: increase MX4's *Unison Multiplier* to further enhance Stereo Detune.

## Analog mode

The analog mode button, when enabled, generates slight pitch variations for each note, but does not allow the notes to drift out of pitch once they are started.

## STATUS

The status LCD (Figure 4-7) displays information about the parameter you are currently modifying or targeting with the cursor. On the left, it shows the parameter name and its current value. If the parameter is being modulated, the modulation source and range is displayed on the right-hand side.

## Active voices

On the far right of the status LCD, MX4 displays the number of currently active voices (notes) it is playing. You can use this display to determine how many voices a passage of music requires, so that you can adjust the polyphony setting (“Polyphony” on page 23) to be equal to (or just above) the required number of voices for the music MX4 is playing. This conserves your computer’s processing resources by limiting MX4’s polyphony to only the number of voices your music actually requires.

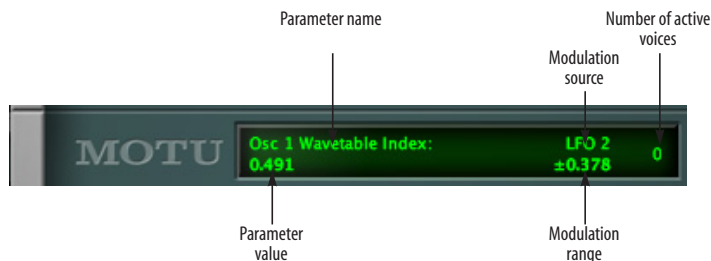

Figure 4-7: The Status LCD.

## OSCILLATORS

MX4 provides three oscillators.

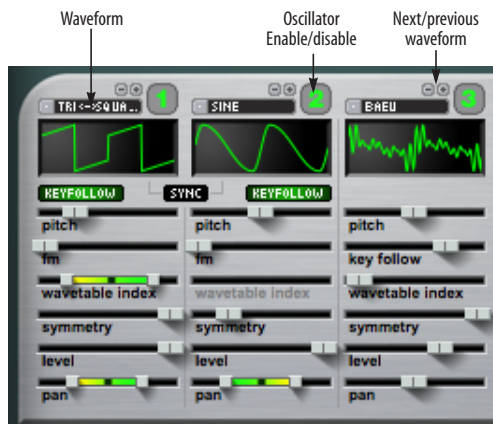

Figure 4-8: The Oscillators.

## Signal flow

MX4’s overall signal flow bears a striking resemblance to a Memorymoog (three oscillators, mixer, filter, amplifier.) But it is best not to treat each oscillator as a separate synthesizer. This is not really the intended operation of MX4 (although this can be accomplished to a limited degree with careful modulation of the individual oscillator level controls). Instead, think of the oscillators as going into a mixer before being processed, because that is exactly what is happening, as shown in Figure 4-9:

### Oscillator enable/disable

Click the enable/disable button (Figure 4-8) to turn the oscillator on or off.

### Waveforms

Choose the desired waveform for the oscillator from the menu, or use the +/- buttons to cycle through the list of waveforms. (If a wavetable is currently selected, hold down the option key while clicking the +/- buttons to cycle out of the wavetable sub-menu and return to the main waveform menu.)

Each oscillator provides a variety of standard subtractive synthesis waveforms. An extensive library of wavetable waveshapes are also provided.

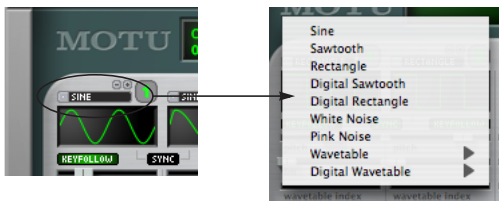

Figure 4-10: Oscillator waveforms.

### Sine



This is a standard sinusoidal waveform.

### Sawtooth



This is a standard sawtooth wave. Use the symmetry parameter to morph the sawtooth waveform

between a downward triangle and an upward triangle waveform:

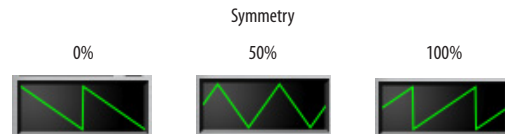

Figure 4-11: Use symmetry to morph between these three basic waveforms.

A sawtooth wave (50% symmetry) has energy at all harmonics, and the strength of higher partials falls off linearly. A triangle wave has less energy at high partials, and strength falls off exponentially as the square of the partial number.

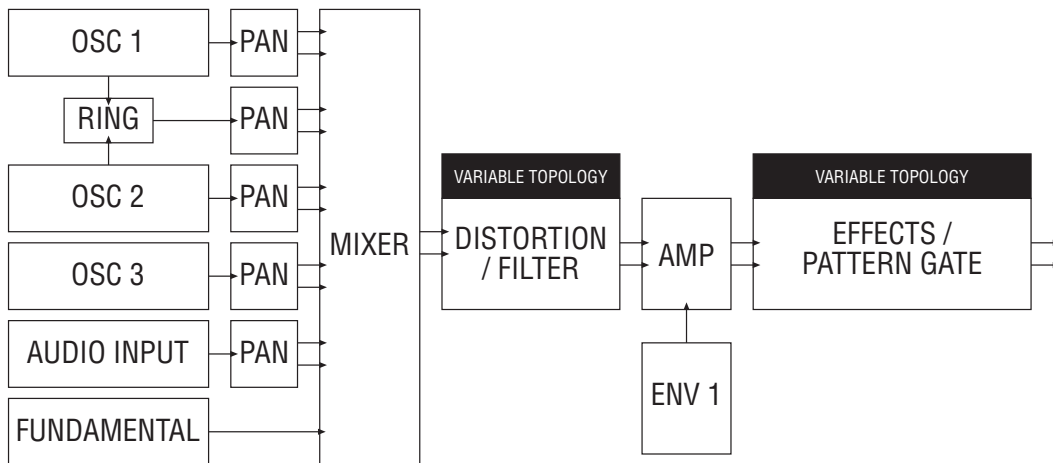

Figure 4-9: MX4 signal flow.

## Rectangle



This is a standard square wave. The pulse width can be modified into a rectangle waveform using the symmetry control (“Symmetry” on page 30).



Figure 4-12: Adjust the symmetry control to create a rectangular wave form.

## Digital Sawtooth



The *Digital Sawtooth* is the same as the sawtooth waveform except that it uses much less CPU

bandwidth. The trade-off, however, is that it can introduce aliasing. This aliasing may or may not matter, depending on the nature of the sound you are creating. Since CPU efficiency is always desirable, try using the digital sawtooth wherever possible. Try switching between digital sawtooth and regular sawtooth to see if there is any noticeable difference in the sound of the preset.

## Digital Rectangle



The *Digital Rectangle* is the same as the rectangle waveform except that it uses much less CPU

bandwidth, as explained above for the *digital sawtooth*.

## White Noise



This is standard white noise (random noise with equal energy per frequency).

## Pink Noise

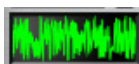

This is standard pink noise (random noise with equal energy per octave).

## Wavetables

Wavetables are sets of complex waveforms that provide a rich assortment of harmonic content and tone color for a sound. Each wavetable is provided

in two different forms, accessed by the two different wavetable sub-menus: *Wavetables* and *Digital Wavetables* (Figure 4-13).

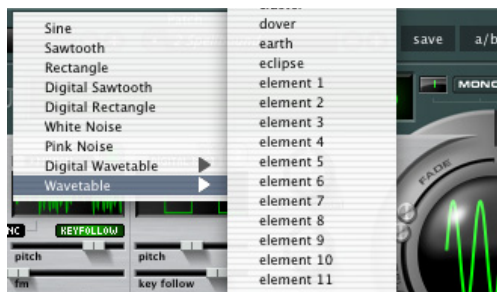

Figure 4-13: Band-limited (anti-aliased) wavetables are now available in the ‘Wavetable’ oscillator waveform sub-menu. Version 1’s classic wavetables are found in the ‘Digital Wavetable’ sub-menu.

In waveforms in the *Wavetables* menu are completely anti-aliased (band-limited), so they do not exhibit the harsh, aliasing quality you might hear when playing their digital wavetable counterpart, especially in the upper pitch registers.

If you are looking for a more “harsh” or “digital” sound, try using a waveform from the digital wavetable sub-menu, which have a strong kinship with MX4’s *digital saw* and *digital square* waveforms.

## Using wavetables

A wide variety of wave tables are provided, including ones that produce a mix of square, triangle or saw waveforms to simulate the effect of having multiple waveforms selected on a vintage synth. The advantage in MX4 is that the mix of these waveforms (wavetable index) is modulatable (see “Modulation” on page 36). MX4 wavetables also have adjustable symmetry, just like the pure waveforms (see “Symmetry” below).

Wavetables can produce spectra that differs greatly from standard subtractive synthesis waveforms. Changing wavetables is an easy and rewarding way

to get into patch programming. Simply find a patch you like, and audition different wavetable waveforms.

Each wavetable is actually a collection of many different waveforms. Some wavetables morph smoothly, and others are collections of many completely unrelated waves. The *bosch* wavetable, for example, is a single wavetable containing 256 individual waveforms!

Modulating the wavetable index is an easy way to add movement to your patches. If you modulate the wavetable index with one LFO, and modulate waveform symmetry with another LFO, the combined effect is that the waveform will never be quite the same at any given moment - and that is just with a single oscillator.

Because wavetables can sound like filtered subtractive waveforms, sometimes you can use wavetables without any filtering at all, which saves CPU overhead.

### Oscillator keyfollow

When the *keyfollow* button is enabled, the oscillator adjusts its frequency relative to the note being played. Accordingly, when keyfollow is enabled, the *pitch* of the oscillator is expressed in the number of semitones relative to the root pitch of the note being played, as explained later.

Oscillator three offers adjustable key follow via the *Key Follow* slider, providing even more expression. The range can be summarized as follows:

#### Key follow value

-200%	Oscillator frequency offset is double the interval from the root pitch and inverted. For example, when you play an octave above middle C, the oscillator plays two octaves down.
-100%	Oscillator frequency is fully inverted for each pitch. For example, playing C below middle C on your keyboard produces the pitch that is one octave above middle C.
0%	The keyboard has no effect on the pitch of the oscillator. The fixed pitch of the oscillator is determined entirely by the pitch parameter.
100%	Oscillator frequency offset remains fixed across all pitches (just like the keyfollow buttons for oscillators 1 & 2).
+200%	Oscillator frequency offset is double the interval from the root pitch. When you play an octave above middle C, the oscillator plays two octaves up.

To take full advantage of oscillator 3's variable keyfollow feature, set the key tracking to zero and listen to how the pitch is fixed across the keyboard. Then adjust the key tracking to see how it changes.

### Oscillator sync

Click the *Sync* button to sync the frequency of oscillator 2 to oscillator 1. This forces oscillator 2 to restart at the beginning of its phase cycle when oscillator 1 reaches the beginning of its phase cycle. Within the middle of each oscillator 1 phase cycle, oscillator 2 runs freely.

Oscillator sync usually produces useful results when oscillator 2 is running at a frequency that is significantly higher (2 or more times) than oscillator 1.

To produce classic Prophet Five synced oscillator sounds, turn on oscillator 2 only (by itself), enable sync, and modulate the pitch of oscillator 2 with an envelope or LFO.

## Pitch

Use the *Pitch* slider to offset the pitch of the oscillator from key tracking. When the *keyfollow* button is disabled, the range is expressed in absolute frequency (Hz or kHz); the range is from 8.2 Hz to 22.1 kHz.

When the keyfollow button is enabled, the pitch is expressed in semitones relative to the root pitch of the note being played. The range is from -60.00 semitones to +84.00 semitones.

## Frequency modulation

Oscillator 3 can serve as an FM source for the pitch of oscillator 1 and 2, as well as the frequency of filters 1 and 2. All of these components (oscillator 1, oscillator 2, filter 1 and filter 2) have an FM slider, which brings in oscillator 3 as an FM source and allows you to choose the amount of frequency modulation to apply in each case.

### Using oscillator 3 as an LFO with key tracking

The pitch slider of oscillator 3 has a very wide range, allowing you to use oscillator 3 as an LFO source. With access to adjustable key tracking (normal LFOs cannot track the keyboard), and wavetables (which produce very interesting LFO shapes), oscillator 3 can produce truly unique periodic modulation effects.

### Frequency modulation tips

In the audible range, oscillator 3 is the modulation source for two operators. The operator structure would look like this:

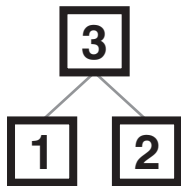

Figure 4-14: Frequency modulation operator structure.

FM is most predictable when using sine waves. Modulate the pitch of oscillator 3 and the FM sliders on oscillator 1 and 2 to create interesting FM sounds. After you're familiar with sine waves, try experimenting with the symmetry parameter and different waveforms.

Using velocity as a modulation source for FM amount or oscillator pitch provides a rich range of expression.

Simple structure FM sounds are very useful for synthetic percussion.

## Wavetable index

The wavetable index allows you to specify any desired waveform in a wavetable for the oscillator. By modulating the wavetable index parameter, you can achieve a wide variety dynamic sounds, depending on the waveforms in the table.

## Symmetry

The symmetry parameter adjusts pulse width on rectangle waves, but symmetry can also be applied to sine waves, sawtooths and even wavetables. Doing so produces interesting changes in harmonic content. Further interesting effects can be achieved by modulating the symmetry (see "Modulation" on page 36).

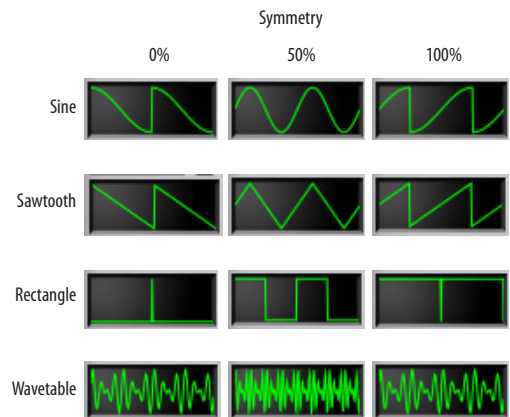

Figure 4-15: Symmetry.

## Level and Pan

Each oscillator has its own independent level and pan going into the mixer. See “Mixer” on page 46.

## Modulating oscillator settings

All continuously variable oscillator settings (ones that have a value slider) can be modulated. Option drag the control to set the modulation range. For further details, see “Modulation” on page 36.

## FILTERS

MX4 provides two multimode variable-slope filters.

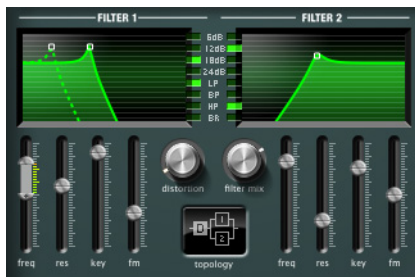

Figure 4-16: the filter section.

## Filter topology

The signal path for the two filters, plus the additional distortion unit, can be configured with the topology menu.

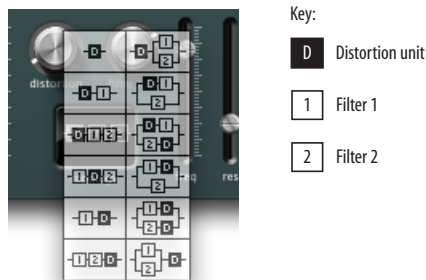

Figure 4-17: The filter topology menu.

The “D” box represents distortion. The boxes labeled 1 and 2 represent Filters 1 and 2. Signal flow proceeds from left to right.

## Enabling/disabling filters and distortion

To enable one or both of the filters, choose the desired signal path from the topology menu, as shown in Figure 4-17.

To turn off both filters, choose the first topology assignment (distortion only) and turn the distortion volume all the way down. No distortion is applied when distortion is set to zero.

The most classic configuration here is the distortion module, plus one filter.

## Filter type

Each filter can be assigned to one of four different filter types (shown below) and four different slopes (6, 12, 18 and 24dB per octave), using the illuminated buttons between the two filter graphs:

Symbol	Filter type	Sample
LP	Lowpass	
BP	Bandpass	
HP	Highpass	
BR	Band reject (notch)	

To achieve more extreme slope effects, choose a filter topology that puts the two filters in series, and then apply the same settings to both filters. (See “Copy this item to all others” on page 51.) In this configuration, their slope values combine to

achieve values greater than 24dB. For example, if you set them both to 24dB, the combined effect is 48dB of slope.

### Filter mix

Use the Filter Mix knob to control the gain (amount) for each filter effect for parallel topology settings (where the signal is split and fed to each filter independently). For serial and stereo filter topology settings, the filter mix control is disabled.

The mix range is from 0% to 100%, where the amount of each filter is as follows:

Filter mix setting	Amount of Filter 1	Amount of Filter 2
0%	100%	0%
25%	75%	25%
50%	50%	50%
75%	25%	75%
100%	0%	100%

If you set one filter to lowpass and the other to highpass, use the filter mix control to attenuate the “buzz” effect of highpass filter.

If you set each filter to a different filter type, routing mod wheel to the filter mix knob often produces interesting results.

### Distortion

To apply *distortion* (also commonly referred to as *drive*), choose a topology that includes distortion (Figure 4-17) and then use the *Distortion* knob to adjust the amount.

### Frequency

The frequency slider determines the filter’s *cutoff* or *center frequency*. Most synthesizers express cutoff/center frequency as a number of cycles per second (Hz or kHz). However, most of the time, key tracking is applied to filters to avoid undesirable artifacts. For example, a lowpass filter will cause notes to get more dull as you play higher pitches

(which have higher frequencies). With key tracking, Hz and kHz are not meaningful because the filter’s center frequency is not fixed at an absolute frequency; instead, it is relative to the note being played. Therefore, MX4 expresses filter cutoff/center frequency in semitones relative to the pitch being played.

### Resonance

Resonance emphasizes the cutoff/center frequency of the filter.

### Filter Key follow

Both filters are equipped with adjustable key follow. This feature works similarly to oscillator 3’s key follow. See “Oscillator keyfollow” on page 29.

### Filter frequency modulation

Oscillator 3 can serve as an FM (frequency modulation) source for the frequency of each filter. Use the FM slider to bring in oscillator 3 as an FM source at the desired amount.

Try setting the frequency of oscillator 3 to a harmonic of oscillator 1 (such as +12 or +19 semitones). Doing so locks in the filter at that frequency to produce harmonic results.

### Modulating filter settings

All of the filter settings, including filter mix and distortion, can be modulated. Option drag the control to set the modulation range. For further details, see “Modulation” on page 36.

### Using the filter graphs

Use the control point on the filter graph to adjust the frequency and resonance graphically. When modulating the filter frequency, a secondary (dashed) frequency plot indicates the lowest frequency in the modulation range, as demonstrated below in Figure 4-18:





Figure 4-18: Adjusting the frequency modulation range in the filter graph.

## ENVELOPES

MX4 provides four six-stage DADSHR envelopes, which can be used as a modulation source for any modulatable parameter.

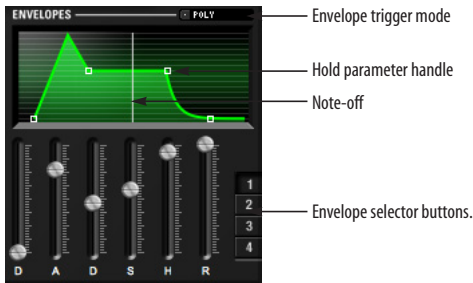

Figure 4-19: Envelopes.

### Choosing an envelope

To choose one of the four envelopes, click the desired selector button as shown above.

### The envelope graph

The envelope graph provides a visual indication of the six stages for each envelope. These stages are described in the next section. The vertical white line in the middle of the graph represents the MIDI note-off event (when you release the key). For a further explanation, see “The hold stage” on page 33.

## The six envelope stages

MX4 envelopes provide the following six stages:

Symbol	Stage	Explanation
D	Delay	The amount of time before the attack begins.
A	Attack	The initial stage of the envelope, specified in the amount of time for it to fully open up.
D	Decay	The amount of time between the end of the attack and the beginning of the sustain.
S	Sustain level	The level at which the envelope remains open, where zero is completely closed and 1.00 is fully open.
H	Hold	The length of time the sustain level is maintained. (See “The hold stage” below.)
R	Release	The final stage of the envelope, where it closes down to zero, specified in the length of time from the end of the hold to the moment when it reaches zero.

### Envelope 1 and amplitude modulation

MX4’s amplifier is not presented graphically in the MX4 window. Instead, there is a dedicated overall volume control and dedicated velocity > volume slider (see “Vel > Volume (Velocity sensitivity)” on page 25). However, envelope 1 is “hardwired” to overall amplitude modulation.

All envelopes, including envelope 1, are freely assignable modulation sources.

### The hold stage

The hold stage can be specified in three different possible ways:

Method for specifying hold time	What to do in the envelope graph
As a finite amount of time after the decay	Drag the hold handle to the left of the note-off line (Figure 4-19).
Indefinitely, until a MIDI note-off message is received	Option-double-click the hold (“H”) slider.
As a finite amount of time after a MIDI note-off message is received	Drag the hold handle to the right of the note-off line (Figure 4-19).

Graphically, this is represented by the relationship between the hold parameter handle (Figure 4-19 on page 33) and the note-off line (also shown in

Figure 4-19). Drag the handle to the left of the note-off line to specify the hold stage as a finite amount of time after the decay. Drag it to the right of the note-off line to specify the hold stage as a finite amount of time after a MIDI note-off message is received. To hold indefinitely until a note-off is received, option-double-click the hold (“H”) slider (so that the status LCD reads *until note off*). Doing so turns off the hold stage to create a standard ADSR envelope.

### Envelope trigger mode

Each envelope can be uniquely assigned to one of the following trigger modes, chosen from the trigger mode menu (Figure 4-19 on page 33):

Trigger mode	Explanation
Poly	Each separate note that is played is given its own unique envelope cycle.
Poly release	Same as above, except the envelope is triggered by the note-off (instead of note-on). This is useful for envelopes 2-4 because you can have an entirely different envelope effect during the release phase.
Mono	All notes share the same envelope.
Mono retrigger	Same as above, except that every time you play a new note, the envelope is retriggered.
External	Allows you to trigger the envelope with MIDI notes from a MIDI controller or another MIDI track (using the MX4 trigger input).
Sequenced	Available for LFOs 2-4 only. See “Trigger sequencer” on page 45.

When an envelope is polyphonic, and it is applied to a polyphonic modulation destination, each “voice” (note) has its own dedicated envelope onset. This is especially useful for polyphonic modulation destinations like those found in the oscillator and filter sections. For mono destinations, such as the parameters in the effects section, best results can be obtained with one of the mono envelope trigger modes.

### External triggering

Choosing the *External* trigger mode allows you to trigger envelopes via a MIDI note played from your MIDI controller. Use MX4’s extra MIDI input to route the external MIDI signal to MX4. In Digital Performer’s list of MIDI destinations, it appears as *MX4 Trigger*.

Once you’ve routed your live MIDI controller signal to the MX4 trigger input via Digital Performer’s patch thru feature, press the following keys to trigger envelopes 1 through 4:

Note (any octave)	Triggered envelope
C	Envelope 1
D	Envelope 2
E	Envelope 3
F	Envelope 4

### LFOs

MX4 provides six LFOs (Low Frequency Oscillators), which can be used as a modulation source for any modulatable parameter. LFOs can modulate other LFOs, and they can even self-modulate.

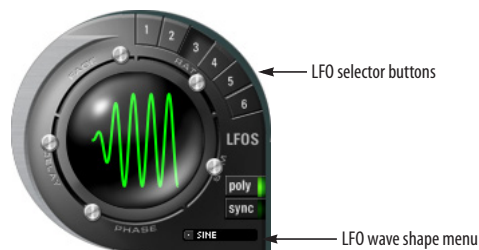

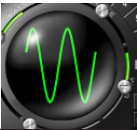





Figure 4-20: The LFOs.

### Choosing an LFO

To choose one of the six LFOs, click the desired selector button as shown above.

## LFO wave shape

Choose the desired LFO wave shape from the wave shape menu (Figure 4-20):

LFO wave shape	Example
Sine	
Saw	
Rectangle	
Sample and hold	
Sample and ramp	
Random walk	

## LFO parameters

LFOs have the following modulatable parameters:

LFO parameter	Unit	Explanation
Rate	Hertz (Hz)	The number of cycles per second at which the LFO oscillates. The range is from 0.0001 Hz to 25 Hz.
Fade (In)	Milliseconds (ms)	Applies an amplitude ramp (from zero to 100%) to the LFO.
Delay	ms	The amount of time before the LFO begins oscillating after being triggered.
Phase (Start Phase)	Degrees	Controls the point during the LFO cycle at which the LFO begins oscillating when first triggered. For random phase, move the slider all the way to the right.
Symmetry	percent	Symmetry applies a non-linear transform to the waveform that skews the axis of the cycle, as demonstrated in Figure 4-15 on page 30. For a rectangle, this is equivalent of its duty cycle, or “pulse width”. For a sawtooth wave, symmetry changes from a triangle with a downward ramp to a triangle with an upward ramp. For sine waves, the effect is similar to the triangle.

## Random phase

To make the phase of an LFO random (each time it is triggered), move the *Phase* slider almost all of the way to the right. The second to last setting is *Random*. The last setting is *Free* (described below).

## Free-running phase

When you move the *Phase* slider all the way to the right, you’ll see a setting called *Free*. With this setting, the LFO runs freely and continuously, on its own, regardless of whether notes are being triggered or not. The result is that the LFO runs completely independently of the notes you are playing. For example, you could apply the LFO to filter cutoff frequency and play a series of notes

where the resulting filter cutoff sweep effect is applied across the notes you are playing, independently of the actual notes.

### Symmetry

Symmetry does not apply to (and is therefore disabled for) the following LFO wave shapes: Sample and hold, Sample and ramp, and Random walk.

For further information about modulating these LFO parameters, see “Modulation” on page 36.

### Polyphonic LFO triggering

Each LFO can operate as either a mono or a polyphonic modulation source. When a LFO is polyphonic, and it is applied to a polyphonic modulation destination, each “voice” (note) is given its own unique LFO onset when it is played. This is especially useful for polyphonic modulation destinations like those found in the oscillator and filter sections. For mono destinations, such as the parameters in the effects section, best results can be obtained with mono LFO triggering (turn *poly* mode off).

### LFO sync

The sync button (Figure 4-20), when enabled, makes the LFO synchronize to the tempo of Digital Performer’s time line. Accordingly, when sync is enabled, the LFO rate parameter is expressed in beat values (whole note, half note, quarter note, etc.)

The sync button is actually a 3-way button. Click it once to enable LFO rate sync (green). Click it again to enable both rate *and* phase sync (orange). In this mode, the phase is also synchronized to tempo. Click a third time to turn off sync (dark). Click repeatedly to cycle through these three modes.

## MODULATION

MX4 has a flexible and powerful modulation architecture. The modulation section (Figure 4-21) is most easily understood if you think of it as a modular synthesizer that uses control voltages to manipulate the sound.

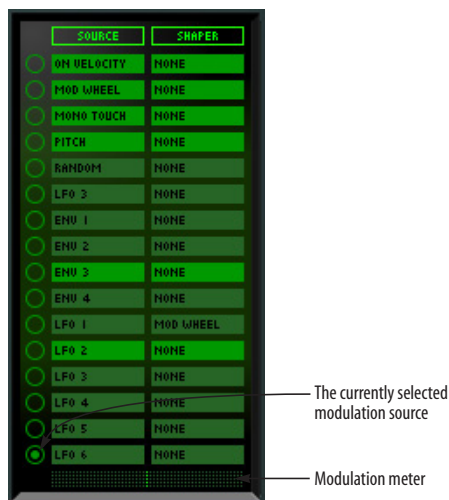

Figure 4-21: The modulation section.

### Modulation sources

There are 16 modulation sources (rows) in the modulation section. Each modulation source row includes a selection radio button, a *Source* menu and a *Shaper* menu. Choose the desired source and shaper (if any) from the menus. To select a modulation source, click its radio button. Only one modulation source can be selected for destination assignment at any given time.

### Assigning a source to a destination

Once you’ve selected a modulation source (by clicking its radio button), assign it to any continuously variable parameter in the MX4 window by option-dragging the handle of the parameter’s slider. As you do so, you’ll see the handle split in half to cover a range over which the parameter will be modulated by the source. In addition, the modulation range will glow green.

You can option-drag as many different parameters as you like. A source can modulate any number of destinations simultaneously (as explained further in the next section).

Here's an example: select the *route filter modulation* preset (patch) from the *Tutorial Patches* bank. Select the modulation source containing LFO 1. Now locate the filter cutoff frequency for filter 1 (labeled *freq*), hold down the option key and drag. You should see an illuminated modulation range for that modulator. Trigger a note and listen. Now change the rate of LFO 1 in the LFO section and listen to the change.

### Assigning a source to multiple destinations

In MX4, a source can modulate any number of destinations simultaneously. When you've selected a modulation source (by clicking its radio button), you can assign it to multiple MX4 parameters by option-drag the slider handle of each parameter.

### Assigning multiple sources to one destination

Up to 16 modulations (all of them) can be applied to any single modulation destination. Modulation sources are summed at the destination, so be careful. Similar to mixing audio tracks, it is possible to exceed the overall allowable modulation range (similar to the way an audio signal can clip when it reaches zero dB). Unlike audio clipping, however, exceeding the modulation range has no negative effect on the sound. However, the modulation might get "pinned" to one end of the range or the other, preventing a smooth swing through the full modulation range. So, if you intend to have multiple modulators modify a single destination, be aware of the total amount of modulation you are applying.

### Daisy-chaining sources

Notice that you can modulate one source with another. For example, you could modulate LFO 2 with LFO 1, while using LFO 2 as a source for modulating other parameters. Daisy-chaining

sources in this manner can be done with any internal source (LFO, envelope or ramp), as well as external sources.

### Self-modulation

Sources can modulate themselves. For example, you could choose LFO 3 in the *Source* list, and then option-drag LFO 3's rate slider to modulate the rate with itself.

### Source highlighting

Source slots (menus) have three illumination states:

illumination state	Meaning
Dark	The source is not being used in the current preset.
Glowing	The source is modulating at least one parameter in the preset.
Lit up	The source is modulating the parameter currently beneath the cursor.

As you glide the cursor over parameters that currently have a modulation range assigned to them (a green track beneath the slider or around the knob), the source for that modulation will light up in the *Source* section so you can clearly see what which source is modulating the parameter.

### Sources

Modulation sources fall into three general categories:

- Internal modulators (MX4's own LFOs, envelopes, ramps and modulators)
- External modulators (MIDI controllers)
- Digital Performer plug-in automation

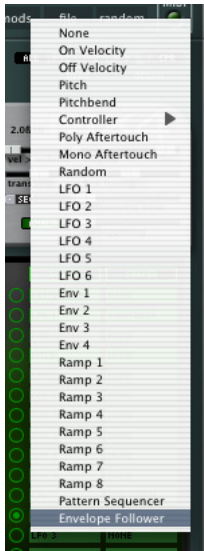

Figure 4-22: The source menu shows external sources (MIDI controllers) and internal sources (LFOs, envelopes, ramps and programmable modulators).

### LFOs and envelopes

You can use MX4’s six LFOs and four envelopes as modulation sources. Each LFO and envelope (or other source) should only be chosen in one source menu at a time, as you can easily map that single source to multiple destinations as described earlier. Choosing a source in more than one source menu at a time doesn’t really serve any useful purpose, and it unnecessarily uses up source slots.

### Plug-in automation

MX4 fully supports the plug-in automation features in Digital Performer. Each parameter in MX4 has its own dedicated automation input. This automation operates independently from MX4’s modulation section, although it can be combined with any modulation sources.

### Ramps

The *Source* menu provides eight general-purpose ramps. The ramps exist as a level of indirection between Digital Performer’s automation system and the MX4 parameter being automated. For example, you may wish to automate the cutoff

frequency of both filters simultaneously. You could use the dedicated automation controls and duplicate the automation data, but a more elegant solution is to use a ramp, assign the ramp to the parameters you wish to automate, and then create a single automation stream in Digital Performer for the ramp. This technique has the added benefit of providing the ability to remap the automation into a performance control with a single modulation reassignment: in the modulation section, simply change the ramp to mod wheel (or other MIDI controller).

### Pattern Sequencer

The *Pattern Sequencer* in the modulation source menu (Figure 4-22) is programmed on the Mods page (Figure 4-24 on page 40). It provides a means to modulate (or shape the modulation of) MX4 parameters in a stepped fashion. See “Pattern Sequencer” on page 42.

### Envelope Follower

The *Envelope Follower* in the modulation source menu (Figure 4-22) is programmed on the Mods page (Figure 4-24 on page 40). It transforms the amplitude of an audio input into a control signal for use inside MX4, as either a modulation source or a shaper. See “Envelope Follower” on page 43.

### Bipolar sources

Most modulators, like MIDI controllers and envelopes, are unipolar (i.e. they have a scale that extends either positively or negatively in one direction). LFOs are bipolar (i.e. they have a scale that extends both positively and negatively from a zero point). Therefore, when assigning an LFO, the modulation range extends symmetrically from the zero point, which is defined as the value of the slider at the moment you assigned the LFO source.

### Inverting the modulation range

In some situations, you may want to swap the endpoints of a modulation range. MX4 has a handy function to swap the endpoints of the current

modulation range. This is accessed via the contextual menu. You can also invert the current modulation range from the contextual menu. For details, see “Contextual menus” on page 51.

## Shapers

Each modulation source is optionally followed by a shaper, much like the Minimoog® Voyager™. A shaper multiplies the output of the modulation source by the shaper output. A common use of a shaper would be to limit the output of an LFO through the mod wheel. When the mod wheel is down, the LFO has no effect. The LFO is gradually felt as the mod wheel is brought up.

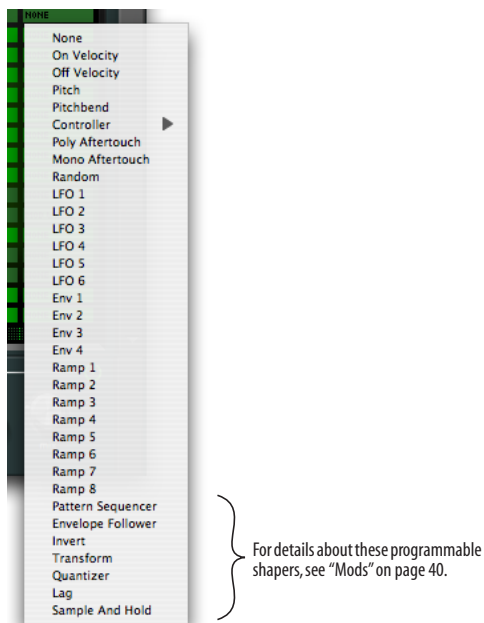

Figure 4-23: Shapers multiply the output of the modulation source by the shaper output

MX4 graphically displays the sum total of modulation and shaper at the destination as a moving bar when a voice is active, so it is easy for you to inspect the cumulative modulation. See the next section for details.

## The modulation meter

The output of the currently selected (active) modulation source can be viewed in the modulation meter (Figure 4-21). For voice dependent modulators, the meter displays activity when you play notes (voices) that are being modulated by the source. For example, if you select an LFO as a modulation source and then play a note, the modulation meter (Figure 4-21) provides a visual representation of the output of the LFO while the note is sustained.

Non-voice dependent modulators, like pitch bend, are always active. In other words, a voice does not need to be triggered to see the modulator’s activity in the meter.

## MODS

Click the *Mods* button (Figure 4-24) to switch the MX4 window to the *Mods* pane, which displays a variety of programmable modulation sources, described in the following sections.

Gate and Effects topology .....	40
Pattern Gate .....	41
Arpeggiator.....	41
Pattern Sequencer.....	42
Envelope Follower .....	43
Invert and Transform .....	44
Quantizer .....	44
Sample and Hold .....	45
Lag Processor.....	45
Trigger sequencer .....	45

## Gate and Effects topology

The Gate and Effects topology section (Figure 4-25) lets you control the order of the two effects slots and the pattern gate with respect to one another.



Figure 4-25: The Gate and Effects topology.

Click a block to enable or disable the effect. When a block is enabled, it glows green. Signal flow proceeds from left to right. Drag the blocks left or right to rearrange their order in the signal flow.



Figure 4-24: The *Mods* pane provides a *Pattern Gate*, *Arpeggiator*, *Envelope Follower*, *Pattern Sequencer*, *Transform*, *Quantizer*, *Sample and Hold*, *Lag Processor* and *Trigger Sequencer*.



## Pattern Gate

The *Pattern Gate* (Figure 4-26) slices up the output of MX4's synth section into pulses determined by the *Speed* menu, which displays metric divisions locked to Digital Performer's tempo.

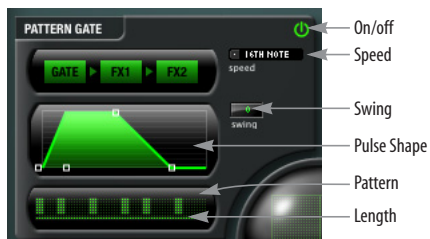

Figure 4-26: Pattern Gate.

The pattern gate can be applied to just about any sound that sustains. Remember, however, that Digital Performer's tempo plays an important role in the results.

### Pulse shape

The shape of each pulse is determined by the *Pulse Shape* graph (Figure 4-27), which represents 100% of the length of each pulse. Drag the handles to modify pulse depth, attack, release and sustain. Drag the *Depth* handle vertically to soften the gate, such as for a tremolo effect.

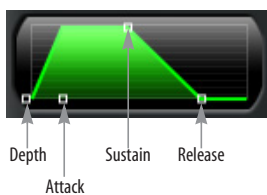

Figure 4-27: Pulse shape.

### Pattern and Length

The pattern itself is determined by the *Pattern* LED graph (Figure 4-26): click each pulse to toggle it on or off. Set the *Length* of the pattern (from 1-16 pulses) by dragging the small line under the pattern. You can invert and/or reverse the Pattern Gate by control-clicking it and choosing the *Invert*

and *Reverse* contextual menu items. Inverting causes steps that are enabled to become disabled, and vice versa.

### Swing

When the *Swing* parameter (Figure 4-26) is set to zero, the pattern gate plays in straight time (no swing). Other settings are as follows:

Swing amount	Ratio	Feel at 8th note speed
0	1 to 1	Straight 8ths
100	2 to 1	Triplet 8ths
125	2.5 to 1	Hard 8th swing
150	3 to 1	Hard 8th shuffle

Negative values invert the ratio, which moves the swung note closer to the base note.

### Arpeggiator

The *Arpeggiator* (Figure 4-28) watches what notes are sounding (being held) and then arpeggiates them (plays them one at a time) at a tempo determined by the *Speed* menu, which displays metric divisions locked to Digital Performer's tempo. If you play a single note, by itself, you'll hear an effect similar to the gate. However, if you play a chord (two or more notes at the same time), the arpeggiator cycles through them one at a time.

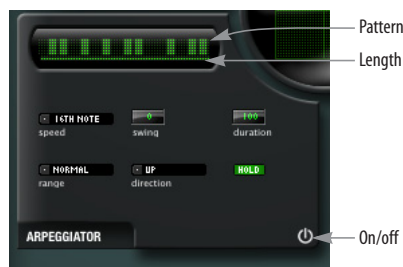

Figure 4-28: Arpeggiator.

## Duration

Set the *Duration* of each note (in percent of the metric value chosen in the Speed menu). 100% equals the chosen metric value (sixteenth note or eighth note, for example). Values less than 100% create shorter note and a more staccato effect.

## Pattern and Length

Specify a pattern to be repeated by the predicator using the *Pattern* LED graph: click each pulse to toggle it on or off. Set the *Length* of the arpeggiator (from 1-16 notes) by dragging the small line under the pattern. You can invert and/or reverse the Arpeggiator by control-clicking it and choosing the *Invert* and *Reverse* contextual menu items. Inverting causes steps that are enabled to become disabled, and vice versa.

## Range

*Range* lets you arpeggiate across a specified number of extra octaves. You can choose *Normal* (no additional octaves) or +1, +2, or +3 octaves. Octaves are added above the octave range in which you play.

## Direction

*Direction* determines the order that the notes play in, as follows:

Direction	Explanation
Up	Plays the notes in order, starting with the lowest, and moving to the highest. Note order: 1,2,3,4,5,6.
Down	Plays the notes in order, starting with the highest and moving to the lowest. Note order: 6,5,4,3,2,1.
Up/Down	First plays Up, then plays Down. Note order: 1,2,3,4,5,6,5,4,3,2.
As Played	Takes into account the order in which you play the notes of a chord and plays them back in the same order as played. The pattern is repeated for each additional octave (if any) specified by the <i>Range</i> option.

## Hold

When the *Hold* light is enabled, notes continue to arpeggiate, even after you release them. They continue to arpeggiate until you play a new note, disable the Hold feature or turn off the arpeggiator.

## Pattern Sequencer

The *Pattern Sequencer* provides a means to modulate (or shape the modulation of) MX4 parameters in a stepped fashion. For example, you could create a sample-and-hold type of effect, except one that is not random but instead programmed and cyclic (repeating).

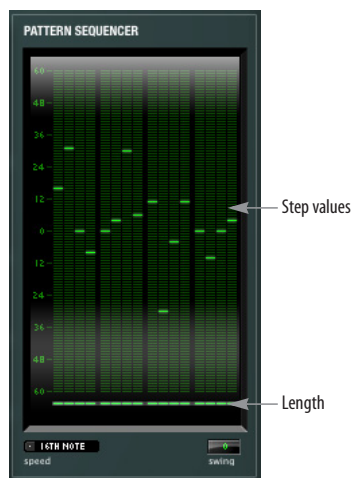

Figure 4-29: Pattern Sequencer.

## Length

Set the *Length* (Figure 4-29) of the pattern, from 1-16 steps, by dragging the right-hand end of the line under the pattern. The pattern proceeds from left to right.

## Step values

Each step can be set to one of 120 possible discrete values (from -60 to +60), where zero (0) equals the base value for the modulation range. Click in the column for each step to specify the value for that step (indicated by the illuminated LED). You can

invert and/or reverse the entire step grid by control-clicking it and choosing the *Invert* and *Reverse* contextual menu items.

### Speed and Swing

The *Speed* and *Swing* parameters operate similarly to their counterparts in the Pattern Gate and Arpeggiator (as discussed on page 41 and page 41).

### Using the Pattern Sequencer

The most obvious use of the pattern sequencer is to send notes to an oscillator. If key follow is on, it might be best to constrain the pattern sequence to highly consonant intervals (like octaves, 5ths, etc.)

Keep in mind, however, that the Pattern Sequencer can be applied to parameters anywhere in MX4, like the filters, effects parameters, wavetable index, etc. Overall, the result often sounds similar to a sample and hold LFO, but the effect is cyclical. Adrenalinn-like guitar effects can be achieved by applying the Pattern Sequencer to the filter for an external input, like a guitar. MX4 can also be used to process the output of another synthesizer or virtual instrument. MX4 can also track your keyboard playing and adjust (in a monophonic way).

### Mapping equal-tempered pitches

To map equal-tempered pitches to an oscillator using the Pattern Sequencer:

- 1 Choose the Pattern Sequencer as modulation source (and make sure its button is enabled).
- 2 Control-click on the oscillator's pitch slider, and choose *Enable the current modulation source* from the contextual menu, if it is not already enabled.
- 3 Control-click the pitch slider again and choose *Set the modulation range for quantizing*.

If you wish to apply the setting to the other oscillators, control-click again and choose *Copy this setting and modulations to all oscillators*.

Additional modulation sources are added at the destination (post quantization), so don't apply both the Pattern Sequencer and Quantizer shaper (page 44) to a single destination if you need equal-tempered results.

### Envelope Follower

The *Envelope Follower* transforms the amplitude of an audio input into a control signal for use inside MX4, as either a modulation source or a shaper.



Figure 4-30: Envelope Follower.

### Audio Input

Choose the desired audio input from the *Input* menu. The inputs that appear in this menu are provided by Digital Performer's bundles. Therefore, you'll need to route the audio signal from the physical input of your audio hardware to the Envelope follower via a virtual bus supplied by Digital Performer.

### Attack and Release

Use the *Attack* (from 1 ms to 1 sec) and *Release* (2 ms to 4 sec) sliders to control the smoothness of the envelope and the speed at which the envelope reacts when the input signal starts and stops.

### Using the Envelope Follower

The Envelope Follower can be used for a wide variety of applications. For example, it can be used to create all sorts of guitar and filter effects, which can be further enhanced with the effects section (including the pattern gate). But there are some other unusual applications. For example, consult the patch called *Sub kick on 1 and 3* in the *External Processing* bank, which adds a tone on those beats, whenever the amplitude is present. As another example, try using a microphone to control wavetable index.

## Invert and Transform

The *Invert* and *Transform* shapers (Figure 4-31) allow you to invert the modulation source. In its default configuration, the *Transform* shaper (Figure 4-31) has no effect. You can customize the response by dragging the handles provided, as demonstrated in Figure 4-31 with the modified *Transform* in the center. For example, you could modify the response curve of incoming continuous MIDI controller data. Completely reversing the handles as shown on the right is identical to *Invert*.

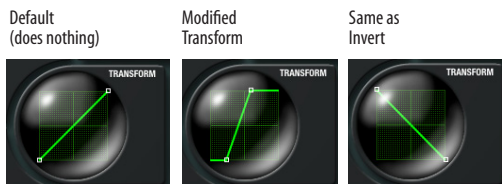



Figure 4-31: The *Transform* shaper.

 **Tip:** Transform can be used to create asymmetrical pitch bend modulation, which can be applied independently per oscillator.

### Using Invert when using MIDI volume as a modulation source

When you modulate a parameter in MX4, the modulation range includes a base value. If you use MIDI volume as a modulation source, you can create a range from the base value down, which causes your MIDI slider (or other controller) to work backwards (moving it down increases the volume, instead of decreasing it). If you invert the modulation range, the slider now maps correctly (moving it up increases volume), but the base value is now at zero, which means that when you save the preset, it won't make a noise until you move your MIDI controller slider. To address this issue, add the *Invert* shaper after the MIDI volume controller modulation source. Doing so causes your MIDI slider to behave correctly, *and* the base value can be saved at a reasonable (non zero) position.

## Quantizer

The *Quantizer* shaper (Figure 4-32) constrains a modulation source to pitch values.



Figure 4-32: The *Quantizer* shaper.

### Range

The *Range* setting (Figure 4-32) lets you specify the number of octaves that the modulation range will be divided into. Octaves are applied evenly across the entire modulation range.

### Pitch Selector

Click the keys on the one-octave *Pitch Selector* to include (blue) or exclude (white) them. This one-octave map is then applied to all octaves specified in the *Range* (above).

### Mode

The *Mode* menu has two settings:

Mode setting	Explanation
Nearest Pitch	Each octave is divided into 12 steps. As the modulation cycles through the octave range, changes only occur on selected notes and are held until the next selected note. This mode can produce uneven, choppy modulation changes, depending on what notes are selected and the intervals between them.
Evenly spaced pitches	Unselected notes are ignored and each octave is divided evenly by the number of pitches you have selected. For example, if you select 4 pitches, you'll hear four changes per octave. Modulation changes occur at evenly spaced intervals throughout each octave, producing a continuous stream of changes that occur smoothly and evenly over time.

The *Quantizer* does not sync to Digital Performer's tempo. Instead, it quantizes to a pitch when a modulating parameter value comes into range for that pitch.

## Sample and Hold

The *Sample and Hold* shaper (Figure 4-33) quantizes modulation transitions to a specific rate or metric duration (if sync is on).



Figure 4-33: The *Sample and Hold* shaper.

## Sync and Rate

If *Sync* (Figure 4-33) is disabled (dark), then the *Sample and Hold Rate* is specified in Hertz. If *Sync* is enabled (illuminated green), then *Rate* is specified in metric divisions (sixteenth note, eighth note, etc.), which lock to Digital Performer's tempo.

## Using the Sample and Hold shaper

MX4's sample and hold LFOs provide the classic sample-and-hold LFO effect, but when you would like a similar but less random effect, try applying the *Sample and Hold* shaper to the output of a shaped LFO, such as a triangle wave.

## Lag Processor

The *Lag Processor* shaper (Figure 4-34) lets you specify different response times for the *Attack* and *Release* of a modulation source. The range for both *Attack* and *Release* is 0.1 ms to 1 second.



Figure 4-34: The *Lag Processor* shaper.

## Using the Lag Processor

You can insert the *Lag Processor* as a shaper after any modulator. For example, you can use it to smooth out aftertouch response. It is also useful when applied to the output of the *Pattern Sequencer* for portamento, or simply to make the transitions less abrupt. For example, it can make filter transitions “slide” to each new pattern point.

## Trigger sequencer

The *Trigger Sequencer* (Figure 4-24 on page 40) lets you trigger an envelope in a stepped, rhythmic fashion as determined by the *Speed* menu (Figure 4-35), which displays metric divisions locked to Digital Performer's tempo.

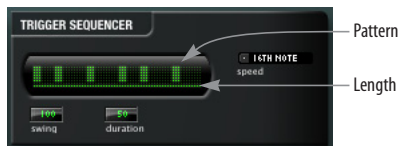

Figure 4-35: The *Trigger Sequencer*.

## Pattern, Length and Swing

The *Pattern*, *Length* and *Swing* parameters (Figure 4-35) operate in a similar fashion as those for the *Pattern Gate*. See “*Pattern and Length*” on page 41 and “*Swing*” on page 41.

## Duration

The *Duration* parameter (Figure 4-35) controls the length of the envelope, where 100 produces the full length of the envelope. Settings lower than 100 will start the envelope release before the end of the metric division (set by *Speed*).

## Applying the Trigger Sequence to an envelope

To apply the *Trigger Sequencer* to one of MX4's DADSHR envelopes (2, 3 or 4), set up the envelope as desired and choose *Sequenced* from the *Envelope Trigger Mode* menu as shown below:



Figure 4-36: Applying the *Trigger Sequencer* to an envelope.

## MIXER

The Mixer (Figure 4-37) provides level and pan control for all of the signals that feed MX4's mixer (Figure 4-9 on page 27).

### Stereo mode

The stereo button enables or disables the pan controls for all oscillators, the ring modulator and the external audio input (if any).

When stereo mode is disabled, CPU bandwidth is preserved. Pan position and automation assignments are preserved, even if you turn off stereo mode.

### Panning

MX4 places panning in a somewhat unorthodox position in the signal flow: on the output of each oscillator, rather than the output of each voice, or after the filters. The pan position can be modulated using polyphonic envelopes and LFOs. For example, a six-note chord could produce a spread of 18 shifting pan positions.

## Fundamental

The *Fundamental* knob controls the volume of the fundamental frequency for oscillator 1, which is blended with other signals feeding into the mixer.

### Ring modulator

The *Ring Mod* knob controls the volume of the ring modulator, which combines the signal from oscillator 1 and 2 and outputs their product into the mixer.

### Audio input

Any external audio input can be fed into MX4 via a mono or stereo sidechain bus. This input is then blended with MX4's own signal. To enable the sidechain input, use the on/off switch provided (Figure 4-37), choose the desired mono or stereo side chain bus from the menu (Figure 4-37) and turn up the audio input gain. Be sure that the audio signal you wish to feed to MX4 is being routed to the same bus in Digital Performer that you chose for a sidechain input into MX4. The external signal is routed internally in MX4 as shown in Figure 4-9 on page 27, where you can apply filter effects, note triggering, and effects.

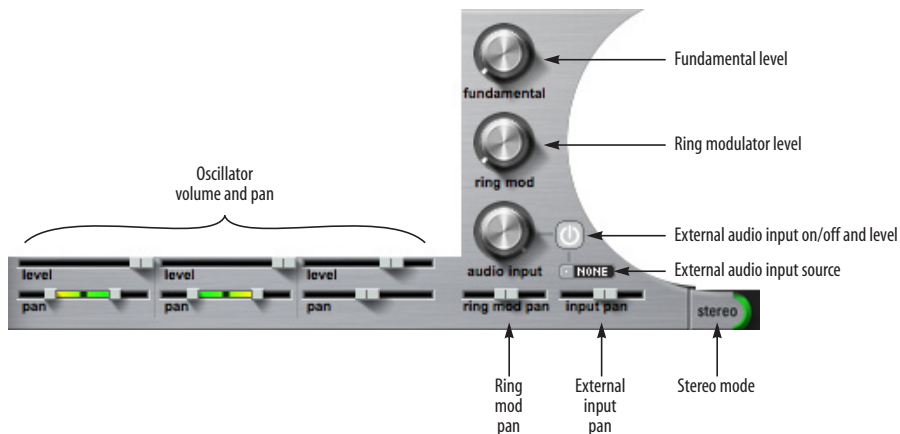

Figure 4-37: The mixer.

## EFFECTS

To view the effects section, click its disclosure triangle (Figure 4-38).

### Effects menus

The effects section provides two effects “slots” in its signal chain for each preset:

- a *modulation* effect slot that provides chorus, phaser or flanger
- a *time effect modulation* that provides reverb or delay

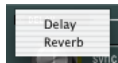
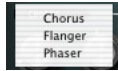

Five effects are provided: Delay, Chorus, Flanger, Phaser and Reverb. Choose the desired effects from the two menus shown in Figure 4-38. The topology of the effects (their placement in MX4’s signal chain) can be determined on the mods page. See “Gate and Effects topology” on page 40.

### Effect slot Enable button

Use the Enable button (Figure 4-38) for each effects slot to enable the effect for that slot. When the button is green, the effect slot is enabled.

## Chorus

Chorus achieves its effect by mixing the input signal with a slightly delayed version of itself. Standard rate, delay, depth and mix controls are provided:

Parameter	Unit	Range	Explanation
Rate	Hz	0.01-2.00	Modulates the delayed signal.
Delay	ms	0-20	Controls the delay time.
Depth	Percent	0-100	Controls the modulation of the delay within the range of the delay setting.
Mix	Percent	0-100	Amount of blend with dry signal.

## Flanger

The *Flanger* creates its effect by mixing the input with a delayed version of itself.



Figure 4-39: Flanger.

### Rate and Depth

*Depth* and *Rate* (Figure 4-39) control the modulation of the delay around 2 ms.

### Feedback

The *Feedback* control (Figure 4-39) adds some of the output back into the input.



Figure 4-38: The Effects section.

## Mix

*Mix* (Figure 4-39) controls the overall level of the Flanger effect mixed with the original signal.

## Phaser

The phaser creates its effect by sweeping notches up and down the frequency spectrum.



Figure 4-40: Phaser.

## Rate

*Rate* (Figure 4-40) controls the rate at which the notch center frequencies are modulated.

## Width

*Width* (Figure 4-40) controls the bandwidth of the notches, within a range determined internally. When *Width* is 100%, the bandwidth is set to the maximum allowed value.

## Depth

*Depth* (Figure 4-40) controls how far the notches sweep.

## Mix

*Mix* (Figure 4-40) controls the overall level of the Phaser effect mixed with the original signal.

## Delay

Use the enable/disable button (Figure 4-38) to add delay. The delay plug-in produces classic delay effects. With stereo processing and separate left/right channel controls, you can create complex stereo and 'ping-pong' delay effects that are saved with the preset.

## Left/Right Delay

These settings control the length of the delay independently for the left and right channel. You can specify delay time in milliseconds or, if the *Sync* button is engaged, by specifying note duration (or bar length).

To generate complex, poly rhythmic effects, try choosing different note values for the left and right channel delays.

## Sync

Engage the *Sync* button to specify the left channel (L) and right channel (R) delay amount in beats and bars. This causes the delay taps will stay in tempo with Digital Performer.

## Out of range

If *sync* is engaged, the *Sync* light blinks when the delay length you've specified makes the total delay time longer than 2 seconds (the maximum time allowed by this plug-in).

Note that the current sequence tempo factors into the delay time for sync-based delays. For example, a quarter note is one second long at 60 bpm but only a half a second long at 120 bpm. So if you specify a whole note delay, and the sequence tempo is 60 bpm, the total delay time you've specified is 4 seconds, which is longer than the 2-second maximum allowed by the plug-in. In this case, the *Sync* light blinks to alert you to this fact. To turn off the light, choose a shorter beat or bar value. Or increase the tempo of the sequence.

## Feedback

The feedback setting controls how much post-delay, post-filtered signal is re-injected back into the delay processor. Used sparingly, these controls can greatly add to the complexity of the delay effect.

⚠ Warning! Be very careful when working with feedback, as it can quickly generate ear-splitting, speaker blowing feedback if you are not careful. When you combine feedback with the highpass or lowpass filter, and then add resonance, the result is instant runaway feedback. The only way to stop this feedback is with Digital Performer's *Stop Sounding MIDI Notes* command (Studio menu).



One way to prevent this sort of feed back is to apply LFO modulation to the filter frequency. This modulates the feedback path and keeps it in check.

### Filter

This is a standard EQ filter that you can apply to the signal before it is fed into the feedback processor. Filter types include low pass, high pass, notch and bandpass filters with appropriate L/R frequency, width and resonance settings, where applicable. This is a great way to apply an ‘effected’ sound to the delay taps, which can add more interest and dimension to the overall delay effect.

### Mix

Controls the overall level of the delay echoes mixed with the original signal.

### Reverb

MX4’s reverb provides several basic controls:



Figure 4-41: Reverb.

### Time

*Time* (Figure 4-41) controls the length of the reverb tail.

### Cut frequency

The *Cut Frequency* (Figure 4-41) provides high-frequency damping.

### Spread

*Spread* (Figure 4-41) controls the amount of stereo spread for the reverb.

### Mix

*Mix* (Figure 4-41) controls the overall level of the Reverb effect mixed with the original signal.

## RANDOM

The *Random* controls let you generate new patches by randomizing parameters of your choice.

Choose any desired patch as a starting point. Then check the parameters you wish to randomize (see “Randomizing tips” below). When you are ready to go, click *Apply*, and then play the patch to listen to the results. To try again, simply click *Apply*.

### Randomizing tips

Overly randomized presets that include modulation assignments can produce rather disturbing results. MX4 includes several useful options for constraining randomization within a preset. For example, you can randomize oscillator parameters, but exclude pitch. Or you can at least constrain pitch randomization to consonant intervals such as octaves or 4ths/5ths.

You might also experience better results by excluding filter topology and filter frequency modulation. Changing the filter topology can change the fundamental nature of the preset. Similarly, filter frequency modulation can easily produce sonic chaos.

If you like the way a patch responds to external control, but you’d like to try variations on how it sounds, then exclude (uncheck) modulation ranges and enables.

## Modifier key legend

The modifier key legend (Figure 4-42) shows you various shortcuts for adjusting the MX4 parameter controls in the main MX4 window.

## Signal path block diagram

The signal path block diagram (Figure 4-42) shows the basic signal path layout of MX4.

## Rear panel grill

Do not attempt to service MX4. Servicing should only be performed by an authorized MX4 service center.

## Apply

Click *Apply* to randomize the current path. Click the *Main* button to return to the main MX4 window.

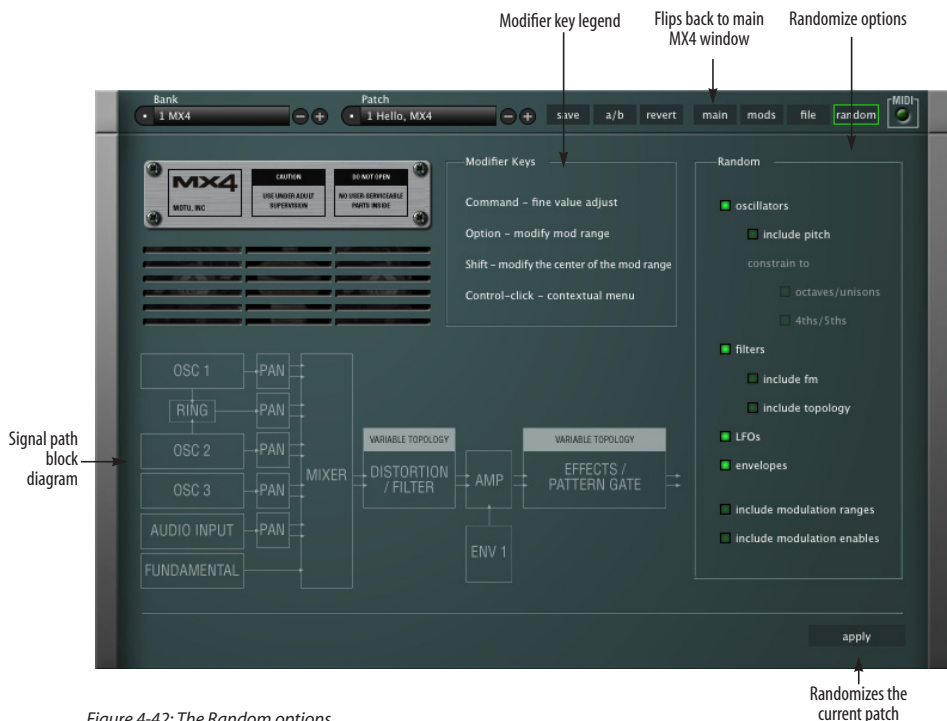

Figure 4-42: The Random options.

## MODIFIER KEY SHORTCUTS

MX4 provides the following modifier key shortcuts:

Modifier key	Target	Operation	Explanation
command	any parameter	fine value adjust	Provides fine-tuned adjustment of any parameter.
control	any parameter	contextual menu	Opens a menu of additional options for the item that you control-click (see the next section).
option	parameter without modulation	add modulation	Applies the currently selected modulation source to the parameter.
option	parameter with modulation	modify modulation range	Adjusts the range of modulation.
option	parameter with bipolar modulation	modify modulation range end points	Adjusts both the top and bottom of the modulation range simultaneously.
shift	parameter with modulation	modify base value	Adjusts the base value of the modulation range.

## CONTEXTUAL MENUS

Hold down the control key (or the right-click button on a multi-button mouse) and click on any item in the MX4 window to view a contextual menu of additional options for that item. What appears in the contextual menu depends on what you control-click.

### Contextual menu items that apply to the entire oscillator, filter, envelope or LFO

For oscillators, filters, envelopes and LFOs, control-click the graphic to see menu items that apply to the entire oscillator, filter envelope or LFO. Control-click a slider to see additional menu items that apply only to the individual parameter.

### Randomize base values

Applies a random value to the base setting for every parameter of the oscillator, filter, envelope or LFO.

**Randomize base values and modulation values**  
Same as *Randomize base values*, with this addition: if a parameter currently has a modulation range, the upper and lower limit of the range are also changed to a random value.

### Copy this item to all others

Applies all settings from the source oscillator, filter, envelope or LFO to all of the others. For example, if you control-click oscillator 1 and choose *Copy this oscillator to all others*, then oscillator 1's settings are applied to oscillators 2 and 3.

### Individual parameters

Control-click an individual parameter (slider or knob) to see additional menu items that apply only to the individual parameter.

### Enable the current modulation source

Causes the parameter to be modulated by the currently selected modulation source (in the *Source* section).

### Disable the current modulation source

Disconnects the parameter from the currently selected modulation source (in the *Source* section).

### Disable all modulation sources

If the parameter is currently being controlled by several modulation sources, this command disconnects the parameter from all current modulation sources.

### Swap current modulation range

If the parameter is currently being controlled by a modulation source, you'll see this menu item, which swaps the base value with the endpoint of the modulation range. For bipolar modulation ranges (which swing between a positive and negative limit above and below the base value), the base value jumps to one of the original range endpoints and the size of the range stays the same. For example, if the base is 50% and the range is +/- 25%, the new base is 75% and the range stays at

+/- 25%. If the original range was +/- 25% (where -25% is first instead of +25%), then the base will jump to 25%.

#### **Invert current modulation range**

If the parameter is currently being controlled by a modulation source, you'll see this menu item, which inverts the modulation range using the base value as the axis for inversion. As a result, the base value remains the same, acting as a "mirror point" for reflecting the modulation range endpoint to the other side of the range. For bipolar modulation ranges (which swing between a positive and negative limit above and below the base value), the modulation range endpoints are inverted.

#### **Invert all modulation ranges**

If the parameter is currently being controlled by several modulation sources, this command inverts all of their modulation ranges, as described above.

#### **Invert and Reverse**

The contextual menus for the Pattern Gate, Arpeggiator, Pattern Sequencer and Trigger Sequencer have *Invert* and *Reverse* items. See their respect sections earlier in this chapter for details.

#### **Randomize base value**

Applies a random value to the base setting for the parameter.

#### **Randomize base and modulations**

Same as *Randomize base value*, with this addition: if the parameter currently has a modulation range, the upper and lower limit of the range are also changed to a random value.

#### **Learn controller mapping**

Lets you assign any external MIDI controller to the parameter. To do so, choose this command and send the controller message you wish to use (move the knob or slider).

#### **Forget controller mapping**

If the parameter is currently assigned to a MIDI controller for external control, you'll see this menu item, which clears the MIDI controller (and disconnects the external control). You can then reassign it, if you wish.

#### **Copy this setting to all others**

Applies the setting from the source parameter to all other similar parameters. For example, if you control-click the *Symmetry* parameter for oscillator 1 and choose *Copy this setting to all others*, then oscillator 1's *Symmetry* value is applied to the *Symmetry* parameters for oscillators 2 and 3.

#### **Copy this setting and modulations to all others**

Same as *Copy this setting to all others*, with this addition: if the parameter currently has a modulation range, the upper and lower limit of the range are also applied to the other parameters, regardless of whether they are turned on or not.

#### **Set the modulation range for quantizing**

This contextual menu command applies to the oscillator pitch sliders. See "Mapping equal-tempered pitches" on page 43 for details.

#### **Global randomize**

To randomize all parameters in the MX4 window in one operation, control-click anywhere in the MX4 window and choose *Global Randomize*.

## CHAPTER 5 **Five Things You Should Know About MX4**

MX4 is perhaps the most powerful and flexible synthesizer of its kind ever devised, due in large part to its powerful modulation system. If each modulation routing had a dedicated knob, the MX4 interface would have over 3500 knobs. To efficiently represent this modulation system on a computer screen, we devised a few, simple user interface metaphors. The power of MX4's interface is its ability to distill its flexible modulation system into a handful of simple gestures. So, even if you are a synthesis guru, here are the Five Things You Need To Know About MX4 to quickly unleash its potential.

### **1. What is a base value?**

The *base value* is the nominal setting of a parameter without any modulation applied to it. Any modulation sets forth from the base value. If a modulation source is not selected, when you move a slider or knob in MX4, you're adjusting the base value. If a modulation source is selected, another way of moving the base value is by using the shift key.

### **2. Modifier keys**

The command key invokes a 'fine' adjust mode. For example, the oscillator pitch slider adjusts in semitone increments. If you hold down the command key, you now have resolution in 1 cent increments.

With a modulation source selected, the option key allows you to create a modulation range, or modify an existing range. This modifier key can be held down together with the command key for fine adjustment of the modulation range.

If you have a modulation range assigned, you can move the defined range using the shift key. What you're essentially doing is moving the base value

only, which you can also do when no modulation source is selected. The modulation range always keeps its position relative to the base value.

Control-click any parameter to reveal a contextual menu of additional parameter-specific operations.

If you forget which key command is which, the random pane provides a handy crib-sheet.

### **3. Bipolar and unipolar modulation sources**

There are two kinds of modulation sources in MX4:

- bipolar (LFOs, pattern sequencer)
- unipolar (envelopes, most MIDI controllers)

*Bipolar* means that the modulation range extends both above and below the base value. *Unipolar* means that the modulation range extends only in one direction (either above or below the base value). Another way to understand the difference is to think of a pitch bend wheel and a modulation wheel. The nominal position of a pitch bend wheel is centered, and modulation can occur above and below the nominal value, making it a bipolar range. On the other hand, a mod wheel's nominal value is all the way down, or zero, and modulation occurs up from zero only, making it unipolar.

MX4 operates in the same way. Modulation ranges behave slightly differently depending on the kind of modulation source you have selected. If you select an LFO, which is a bipolar modulation source, the modulation range extends two end points, center-justified from the base value. If you select an envelope, a unipolar modulation source, the modulation range extends in a single direction away from the base value.

MX4 allows you to directly manipulate modulation range end point handles independently. If you're editing a single endpoint of a bipolar modulation range, be aware you're actually doing two things: editing the modulation range and changing the base value. (Hint: If you just want to edit the modulation range and not the base value, hold down the option key.)

#### **4. The initial modulation gesture is meaningful**

Consider a low pass filter: as you move up its frequency slider, the filter opens. If you move the slider down, the filter closes. Let's say that you want an envelope to control the filter cutoff frequency. When you create the modulation range, your initial gesture determines the direction of the range. If you drag the modulation range up from the base value, the envelope will open the filter as the envelope progresses, just as if you were moving the filter knob up manually. If you drag the modulation range down from the base value, the envelope will close the filter as the envelope progresses. If you accidentally drag in the wrong direction, don't

worry. Control-click the parameter and choose the contextual menu option called *Invert modulation range* to switch it.

The same holds true for bipolar modulation sources. Your initial gesture can phase invert the output of the LFO. For example, if you want an LFO to pan an oscillator from the center off to the right, your initial modulation gesture should move from the base value to the right. Now, with the same LFO, you can create a mirror version of the LFO on another oscillator by dragging left from the base value.

#### **5. What is the white block with the 'D' in it in the topology diagram?**

The white block represents how distortion is positioned in the filter topology. The block labeled '1' is filter 1 and the block labeled '2' is filter 2. The filters are disabled if they are not present in the topology diagram. Distortion is turned off when the knob is all the way off (in the left most position).

# APPENDIX A Troubleshooting

<b>OVERVIEW</b>	
<b>MX4 FAQ</b> .....	55
<b>Conserving CPU resources</b> .....	56
<b>General troubleshooting</b> .....	57
<b>MIDI troubleshooting</b> .....	57
<b>Audio troubleshooting</b> .....	58
<b>Preventing Catastrophe</b> .....	58
<b>Technical support</b> .....	58

## MX4 FAQ

*I have a preset loaded, but I don't hear anything.*  
If you are playing notes from an external controller, make sure the MIDI track or instrument track in Digital Performer is record-enabled. For other MIDI troubleshooting tips, see “MIDI troubleshooting” on page 57.

*MX4's MIDI activity LED is flashing, so it's receiving MIDI data successfully, but I still don't hear any sound.*

It's time to check audio. See “Audio troubleshooting” on page 58.

*When I play on my keyboard, there's a delay before I hear a note.*

In order to get the fastest possible response from MX4, you'll need to set the sample buffer of your audio hardware driver to a low number. Experiment with this setting to get the best response and computer performance. For complete details, see “Buffer Size” on page 27 in the *DP Getting Started Guide*.

*How do I get MX4 to play multiple different sounds?*

Each “instance” of MX4 plays one preset. If you want to play two or more presets at the same time, just open additional instances of MX4, each on its own track.

*When I move the cutoff frequency knob for the Filter, nothing happens.*

Make sure the envelope depth in the filter section is set to a value where you can actually hear the envelope. For example, if you have set the depth to a value of 1 and the attack of the envelope is 0.00, the filter will have no effect at all.

*Why is the output of MX4 is distorted?*

It is possible for MX4 to output more than unity gain. This can happen, for example, if you use resonant filters that add gain. Keep an eye on the output level of the MX4 track and attenuate that signal if it gets too hot.

*How do I record the audio output of MX4?*

Digital Performer can bounce your project to disk without first rendering virtual instruments as audio. Simply include MX4 in your selection of tracks to be bounced.

Alternately, you can manually bus the output of the MX4 track to another audio track, and record the audio output of MX4 onto that track. Here is a step by step procedure:

- 1 Create a new stereo audio track (not the one where MX4 is used) and name it *Record MX4*.
- 2 Route the MX4 track to an unused bus (e.g.: Bus 1-2).
- 3 Select Bus 1-2 as the input pair for your *Record MX4* track.
- 4 Record-arm the *Record MX4* track, and start recording.

If you wish to hear MX4 while recording, engage *Studio menu > Audio Patch Thru > Auto*. In addition, choose *Setup menu > Configure Audio System > Input Monitoring Mode* and choose the *Monitor record-enabled inputs through effects* option.

That's it! MX4 audio output will be recorded into the new track.

*Everything is working fine, except that intermittently, notes don't play for no apparent reason. Why?*

Check your polyphony setting for the part to make sure that MX4 has more than enough voices to play the notes you are feeding it.

### CONSERVING CPU RESOURCES

MX4 provides several settings that are crucial for managing your computer's precious processing (CPU) resources. Another setting, Digital Performer's *buffer size* setting ("Buffer Size" on page 27 in the *DP Getting Started* Guide), can also dramatically impact MX4 performance. In general, settings of 256, 128 or 64 samples produce better latency performance. But lower settings place higher demand on your computer's processor.

#### The Polyphony setting

The Polyphony setting (see "Polyphony" on page 23) lets you control the maximum allowed number of stereo notes that can be played simultaneously by MX4. The upper limit is 256. The more notes that MX4 plays simultaneously, the more work your computer does. The Polyphony settings lets you put a ceiling on the number of notes that will play simultaneously to conserve CPU bandwidth. For further details, see page 23.

### Other ways to optimize MX4 performance

Here are three additional ways you can optimize MX4 performance:

1. Filters require processing bandwidth because they are applied per voice. So be prudent in your sound design when employing one or both filters. Band-pass filters are particularly more "CPU-expensive" than highpass or lowpass filters.
2. Long envelope times can increase the polyphony count — without being obvious. Make sure your amplitude envelope is set only as long as is necessary. For details, see "Envelopes" on page 33.
3. MX4's built-in effect processing will increase the CPU load.
4. Stereo mode doubles the effect of filters because in MX4, the signal is split into stereo before the filters, so be mindful of stereo operation with filters (and lots of polyphony).
5. Polyphony affects CPU bandwidth. In other words, the more notes that MX4 plays simultaneously, the more load is placed on your computers' CPU. You can cap polyphony to limit CPU loading.
6. The unison multiplier multiplies the number of voices you use per note, so only use it if your patch requires it. For details, see "Unison multiplier" on page 24.
7. The digital rectangle and digital sawtooth oscillator waveforms are more CPU-efficient than their non-digital counterparts. Use them whenever possible (when the slight aliasing that can occur with these waveforms is masked by other components of the sound). For details, see "Waveforms" on page 27.

In summary, you can conserve CPU processing in a preset by using only one — or zero — filters, turning off stereo mode, turning off chorus and delay and capping the polyphony.



## GENERAL TROUBLESHOOTING

Troubleshooting is always simplest and most effective when the exact problem can be specified clearly and concisely. If you are surprised by an error message or by seemingly erratic behavior in the program, take a moment to jot down the relevant details: exactly what the error message said (including any error ID numbers), what actions were done on-screen just before the problem occurred, what kind of file you were working with, how you recovered from the problem, and any unusual conditions applying during the occurrence of the problem. This may not enable you to solve the problem at once, but will greatly aid in isolating the problem should it reoccur.

If the problem you are encountering seems inconsistent, try to determine what the necessary pattern of actions are that will cause it to occur. Genuine bugs in application software like MX4 are almost always consistent in their manifestation: the same set of actions under the same conditions invariably brings about the same results. Determining the exact cause of a bug often requires experiments which replicate the problem situation with one factor changed: choosing a different (smaller) preset, turning off 32-bit mode, etc.

If the problem is truly inconsistent, then it is likely to be a hardware problem: a faulty hard drive, a failing computer motherboard, a loose connection, etc.

### *Isolate the problem...*

One of the best troubleshooting techniques is to try to isolate the problem. If you can whittle down a complicated setup or scenario to a much simpler case, chances are you'll zero in on the problem more quickly.

### *Simplify your setup...*

One of the most common causes of problems is a conflict with other software in the system. Run MX4 by itself, with no other plug-ins or virtual instruments, and see if the problem you are having still happens.

### *Check the 'Read Me First'...*

It's human nature to blow right past the Read Me First, but you'll probably be glad you took the time. If you experience problems with MX4, check the Read Me notes that ship with the current version you are using.

### *If you cannot open a particular MX4 project or session in Digital Performer...*

First try opening other existing files, or a new file, to be sure MX4 is working at all. If other files work fine, try temporarily removing the MX4 plug-in, or disable audio in Digital Performer. If other files also exhibit similar behavior, then you know that the problem is not specific to one file.

## MIDI TROUBLESHOOTING

The most important tool for tracking down MIDI input problems is the MIDI Activity LEDs for each part. If there is a hardware problem, or if your channel assignments are wrong, the problem should be apparent by looking at the MIDI LEDs.

In order for external MIDI to get to MX4, the MIDI track or instrument track must be record-enabled. A quick test to determine whether MIDI is reaching the track is to hit record and tap a few notes on your controller. If no MIDI appears in the track, check that your controller and MIDI interface are set up properly. If MIDI data does show up in the track, and your sequencer uses a separate MIDI and instrument track for virtual instruments, make sure the MIDI track output is assigned to MX4 and is assigned to a part that has a preset sound ready to go.

### *If MX4 is unable to play any MIDI data...*

Does Digital Performer receive MIDI data from your MIDI controller? Does MIDI play back successfully to other MIDI instruments? If the answer is no to either question, double-check your cable connections and MIDI controller settings. See if your controller registers in Audio MIDI Setup.

If you are trying to play MX4 from your MIDI controller, make sure that the MX4 MIDI track or instrument track in Digital Performer is record-enabled.

Often only A/B tests will reveal the source of the problem. It may be necessary to switch your MIDI cables, and if possible, to try using a different MIDI interface or synthesizer for input/output. The easiest way to test if MIDI data is actually getting to MX4 is to look at the MIDI activity LEDs in the Parts section.

## **AUDIO TROUBLESHOOTING**

In order for audio to be heard from MX4, the output of the audio or instrument track in Digital Performer must be sent to an output that is connected to speakers or headphones. Can you play back any pre-recorded audio? That's always a good way to check that the rest of the audio system is set up correctly. In some cases, a sequencer requires an available voice for MX4 playback. Make sure all outputs and voice assignments are correct for the MX4 track.

If you still don't hear sound, check the following things:

- Make sure the volume is turned up on the part you are playing, as well as MX4's global volume setting.
- Make sure that the appropriate faders are up in Digital Performer's Mixing Board.

- Make sure you have cables connected to the correct plugs on the outputs of your audio hardware.

## **PREVENTING CATASTROPHE**

*Keep up-to-date backups of your MX4 patches file, so that you always have copies of the most recent work you have done. Almost any software problem is survivable as long as you have kept backups of your work.*

*Keep plenty of free space on your hard drives. This will prevent the Mac from running out of disk space.*

## **TECHNICAL SUPPORT**

We are happy to provide customer support to our registered users. If you haven't already done so, please take a moment to complete the registration card in the front of the manual and send it in to us. When we receive your card, you'll be properly registered for technical support.

Registered users who are unable, with their dealer's help, to solve problems they are encountering with MX4 may contact our technical support department in one of the following ways:

- Technical support phone: (617) 576-3066
- Tech support fax: (617) 354-3068
- Tech support on line: [motu.com/support](http://motu.com/support)
- Web site (for information, tech support database and downloads): [www.motu.com](http://www.motu.com)

Technical support is staffed Monday through Friday 9 AM to 6 PM, Eastern Time.

If you decide to contact technical support, please have your MX4 manual at hand, and be prepared to provide the following information to help us solve your problem as quickly as possible:

- **The version of MX4 you are working with.** This is displayed to the left of the MX4 logo.
- **A brief explanation of the problem,** including the exact sequence of actions which cause it, and the contents of any error messages which appear on the screen. It is often very helpful to have brief written notes to refer to.
- **The pages in the manual** which refer to the parts of the program which you are having trouble with.

We're not able to solve every problem immediately, but a quick call to us may yield a suggestion for a problem which you might otherwise spend hours trying to track down.

Our technical support telephone line is dedicated to helping registered users solve their problems quickly. In the past, many people have also taken the time to write to us with their comments, criticism and suggestions for improved versions of our software. We thank them; many of those ideas have been addressed in this version of MX4. If you have features or ideas you would like to see implemented in our music software, we'd like to hear from you. Please send email to [suggestions@motu.com](mailto:suggestions@motu.com), or write to the MX4 Development Team, MOTU Inc., 1280 Massachusetts Avenue, Cambridge, MA 02138.

Although we do not announce release dates and features of new versions of our software in advance, we will notify all registered users immediately by mail as soon as new releases become available. If you move or otherwise change your mailing address, please send us a note with your change of address so that we can keep you informed of future upgrades and releases.

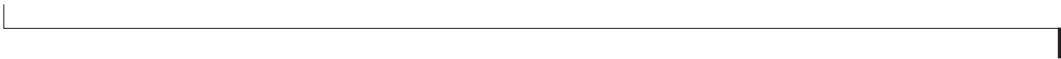

## APPENDIX B Glossary

**32-bit:** Refers to the number of bits used to describe an individual sample. MX4 audio is generated internally at 32-bit resolution (32 bits to describe each sample).

**Amplitude envelope:** Also see *Envelope*. Modulates the volume of a sound over time according to the settings of each envelope stage. Four of the six stages in the MX4 envelope are specified in units of time, and the sustain stage is specified in level (amplitude).

**Audio Unit (AU):** A standard Mac OS X plug-in format. Programs like Digital Performer can host AU plug-ins.

**Automation:** The process of changing a plug-in parameter over time. For example, MX4's filter cutoff frequency can be automated by sending a stream of automation data values that change over time.

**Bend:** The process of changing the pitch of a note smoothly, or the range over which such a change can occur.

**Buffer:** A small portion of computer memory that is used to temporarily store audio data as it is being moved or processed. Larger buffer sizes can increase system latency. See “Buffer Size” on page 27 in the *DP4 Getting Started* Guide.

**Bus:** A connection from one point in a mixing environment to another.

**Cents:** a unit of measurement for pitch transposition. There are 100 cents in a semitone and twelve semitones in an octave. 50 cents is a quarter of a tone.

**CoreAudio:** The term used to refer collectively to the built-in audio services provided by Mac OS X.

**CoreMIDI:** The term used to refer collectively to the built-in MIDI services provided by Mac OS X.

**CPU:** Central Processing Unit. This is the “brain” of a computer, where the majority of the computing is done.

**Cutoff frequency:** The frequency above or below which a digital signal processing filter is applied.

**Effects:** Signal processing applied to an audio signal. MX4 has five effects: chorus, flanger, phaser, delay, and reverb.

**Envelope:** A modulation profile that changes over time, applied to an audio signal. For example, in samplers, amplitude envelopes are applied to samples to produce more dynamic-sounding notes, with distinct attack, sustain and release characteristics.

**Filter:** An audio signal processor that modifies an incoming signal in some way. MX4 provides two classic filters, along with a wide variety of ways to program, modify and modulate them. See “Filters” on page 31.

**Filter modulation:** The process of changing the filter cutoff frequency over time. For details, see “Modulation” on page 36.

**Fine-tune:** A pitch control setting that allows you to change pitch in cents (a hundredth of a semitone). Also see *cents*.

**Frequency:** The rate at which an audio signal oscillates. Also see *cutoff frequency*.

**Gain:** Volume, amplitude.

**General MIDI:** A standardized, basic sound set with a standard organization adopted by the electronic music instrument industry to provide users with a familiar sound set, regardless of the instrument being used to produce the sounds.

**Hardware buffer size:** The size of a small amount of computer memory used to transfer digital audio data to and from external audio hardware. See “Buffer Size” on page 27 in the *DP4 Getting Started Guide*.

**High Pass Filter:** A signal processor that allows frequencies above its threshold to go through and mutes frequencies below its threshold.

**HPF:** See *High Pass Filter*.

**Instance:** An instantiated MX4 plug-in (see *Instantiate* below).

**Instantiate:** Specifically in regards to MX4, this term refers to the process of opening MX4 within Digital Performer as the host software.

**Insert:** A point in a signal chain where an additional signal path loop (out and then back in again) can be added. More specifically, in MX4, an insert is a place where an effect can be added.

**I/O buffer size:** See *Buffer*.

**Key follow:** The amount of keyboard tracking that can be applied to an oscillator. For details, see “Oscillator keyfollow” on page 29.

**Layer:** Multiple presets (patches) that are played simultaneously by the same note.

**Latency:** a very short delay that can occur between when a MIDI note is played and the resulting MX4 sound is triggered. See “Buffer Size” on page 27 in the *DP4 Getting Started Guide* for further information.

**LFO:** See *Low Frequency Oscillator*.

**Low Frequency Oscillator:** A low frequency signal that is used as a control signal for a signal processor (such as a filter).

**Low Pass Filter:** A signal processor that allows frequencies below its threshold to go through and mutes frequencies above its threshold.

**LPF:** See *Low Pass Filter*.

**MAS:** A plug-in format for Digital Performer.

**MIDI:** Musical Instrument Digital Interface. A command and control protocol for electronic musical instruments and software.

**Modulation:** The process of modifying a signal over time.

**Mono:** One channel.

**Multi-timbral:** Producing (or the ability to produce) more than one type of instrument or sound at a time.

**Normalize:** To boost the amplitude of an audio signal by whatever constant amount is needed to make the loudest peak reach digital full scale (zero dB).

**Note-on/off velocity:** A parameter of MIDI note data event that specifies the strength of the attack and release of the note.

**Octave:** A frequency that is higher or lower by a factor of 2. For example, the A above middle C is 440 Hz. An octave higher is 880 Hz. Two octaves higher is 1760 Hz.

**Off-velocity:** See *Note-on/off velocity*.

**On-velocity:** See *Note-on/off velocity*.

**Parallel filters/effects:** Two or more signal processors that can be applied independently to the same input signal.

**Plug-in:** A piece of software that operates within a host application.

**Polyphony:** The characteristic of sounding two or more notes at the same time. More specifically, this MX4 setting determines the maximum number of notes a part can play simultaneously. See “Polyphony” on page 23.

**Preset:** A reference to a patch, which is a “snapshot” of all of the settings in the MX4.

**RAM:** Random Access Memory. This is the portion of a computer where data is temporarily stored during the computer’s operation. When you restart or shut off the computer, RAM is flushed.

**Release velocity:** See *note-off velocity*.

**Resonance:** A boost in amplitude around the cutoff frequency. Also see *cutoff frequency*.

**Serial effects:** Two or more signal processors that can be applied one after the other to an audio signal.

**Stack:** Multiple presets (patches) that are played simultaneously by the same note.

**Threshold:** A specific frequency, amplitude or other audio signal characteristic that is used as a trigger.

**Trigger:** Something that initiates something else. For example, a MIDI note-on event can *trigger* a sound.

**Velocity:** See *note-on/off velocity*.

**Virtual instrument:** Software that produces sounds in a similar fashion to real acoustic or electronic instruments.





## APPENDIX C    NRPN Mapping

MX4 parameters can be remotely controlled by MIDI continuous controller data with the following non-registered parameter numbers:

### **NRPN**            **MX4 parameter that it controls**

NRPN 0	Polyphony
NRPN 2	Unison Detuning Mode
NRPN 3	Unison Linear Detuning
NRPN 4	Unison Logarithmic Detuning
NRPN 7	Lower Pitch Bend Range
NRPN 8	Upper Pitch Bend Range
NRPN 9	Polyphonic Mode
NRPN 10	Legato Mode
NRPN 11	Portamento On/Off
NRPN 12	Portamento Mode
NRPN 13	Portamento Time
NRPN 14	Unison Multiplier
NRPN 15	Arpeggiator Enable
NRPN 16	Arpeggiator Pattern
NRPN 17	Arpeggiator Pattern Length
NRPN 18	Arpeggiator Speed
NRPN 19	Arpeggiator Swing
NRPN 20	Arpeggiator Duration
NRPN 21	Arpeggiator Range
NRPN 22	Arpeggiator Direction
NRPN 23	Arpeggiator Hold
NRPN 1000	Osc 1 Waveform
NRPN 1001	Osc 1 Wavetable Index
NRPN 1002	Osc 1 Key-Follow
NRPN 1003	Osc 1 Pitch Offset
NRPN 1004	Osc 1 FM
NRPN 1005	Osc 1 Symmetry
NRPN 1006	Osc 1 Gain
NRPN 1007	Osc 1 Pan
NRPN 1008	Osc 1 Enable
NRPN 1009	Osc 1 Wavetable
NRPN 1020	Osc 2 Waveform
NRPN 1021	Osc 2 Wavetable Index
NRPN 1022	Osc 2 Key-Follow
NRPN 1023	Osc 2 Pitch Offset
NRPN 1024	Osc 2 FM
NRPN 1025	Osc 2 Symmetry
NRPN 1026	Osc 2 Gain
NRPN 1027	Osc 2 Pan

NRPN 1028	Osc 2 Enable
NRPN 1029	Osc 2 Wavetable
NRPN 1040	Osc 3 Waveform
NRPN 1041	Osc 3 Wavetable Index
NRPN 1042	Osc 3 Key-Follow
NRPN 1043	Osc 3 Pitch Offset
NRPN 1044	Osc 3 FM
NRPN 1045	Osc 3 Symmetry
NRPN 1046	Osc 3 Gain
NRPN 1047	Osc 3 Pan
NRPN 1048	Osc 3 Enable
NRPN 1049	Osc 3 Wavetable
NRPN 1100	Pitch Bend Mode
NRPN 1101	Stereo Detuning
NRPN 1102	Osc Analog Drift Mode
NRPN 1103	Osc 2 Sync
NRPN 1104	Ring Modulation
NRPN 1105	Ring Modulation Pan
NRPN 1106	Fundamental Blend
NRPN 1107	Volume
NRPN 1108	Audio Input Gain
NRPN 1109	Audio Input Enable
NRPN 1110	Audio Input Pan
NRPN 1111	Velocity Sensitivity
NRPN 1112	Filter Layout
NRPN 1113	Distortion Level
NRPN 1114	Filter Mix
NRPN 1115	Stereo Mode
NRPN 1116	Transform 1
NRPN 1117	Transform 2
NRPN 1118	Sample and Hold Rate
NRPN 1119	Sample and Hold Mensural rate
NRPN 1120	Sample and Hold Sync
NRPN 1121	Lag Attack Time
NRPN 1122	Lag Release Time
NRPN 1123	Pattern Seq Speed
NRPN 1124	Pattern Seq Swing
NRPN 1125	Pattern Seq Length
NRPN 1126	Pattern Seq Step 1 Level
NRPN 1127	Pattern Seq Step 2 Level
NRPN 1128	Pattern Seq Step 3 Level
NRPN 1129	Pattern Seq Step 4 Level
NRPN 1130	Pattern Seq Step 5 Level
NRPN 1131	Pattern Seq Step 6 Level

NRPN 1132	Pattern Seq Step 7 Level
NRPN 1133	Pattern Seq Step 8 Level
NRPN 1134	Pattern Seq Step 9 Level
NRPN 1135	Pattern Seq Step 10 Level
NRPN 1136	Pattern Seq Step 11 Level
NRPN 1137	Pattern Seq Step 12 Level
NRPN 1138	Pattern Seq Step 13 Level
NRPN 1139	Pattern Seq Step 14 Level
NRPN 1140	Pattern Seq Step 15 Level
NRPN 1141	Pattern Seq Step 16 Level
NRPN 1142	Quantizer Pitches
NRPN 1143	Quantizer Range
NRPN 1144	Quantizer Mode
NRPN 1145	Envelope Follower Attack
NRPN 1146	Envelope Follower Release
NRPN 1147	Trigger Seq Speed
NRPN 1148	Trigger Seq Swing
NRPN 1149	Trigger Seq Duration
NRPN 1150	Trigger Seq Length
NRPN 1151	Trigger Seq Pattern
NRPN 1200	Filter 1 Mode
NRPN 1201	Filter 1 Order
NRPN 1202	Filter 1 Key-Follow
NRPN 1203	Filter 1 Freq
NRPN 1204	Filter 1 Resonance
NRPN 1205	Filter 1 FM
NRPN 1210	Filter 2 Mode
NRPN 1211	Filter 2 Order
NRPN 1212	Filter 2 Key-Follow
NRPN 1213	Filter 2 Freq
NRPN 1214	Filter 2 Resonance
NRPN 1215	Filter 2 FM
NRPN 1300	Env 1 Trigger Mode
NRPN 1301	Env 1 Delay
NRPN 1302	Env 1 Attack
NRPN 1303	Env 1 Decay
NRPN 1304	Env 1 Sustain Level
NRPN 1305	Env 1 Hold
NRPN 1306	Env 1 Release
NRPN 1310	Env 2 Trigger Mode
NRPN 1311	Env 2 Delay
NRPN 1312	Env 2 Attack
NRPN 1313	Env 2 Decay
NRPN 1314	Env 2 Sustain Level
NRPN 1315	Env 2 Hold
NRPN 1316	Env 2 Release
NRPN 1320	Env 3 Trigger Mode
NRPN 1321	Env 3 Delay
NRPN 1322	Env 3 Attack

NRPN 1323	Env 3 Decay
NRPN 1324	Env 3 Sustain Level
NRPN 1325	Env 3 Hold
NRPN 1326	Env 3 Release
NRPN 1330	Env 4 Trigger Mode
NRPN 1331	Env 4 Delay
NRPN 1332	Env 4 Attack
NRPN 1333	Env 4 Decay
NRPN 1334	Env 4 Sustain Level
NRPN 1335	Env 4 Hold
NRPN 1336	Env 4 Release
NRPN 1400	LFO 1 Waveform
NRPN 1401	LFO 1 Sync Mode
NRPN 1402	LFO 1 Mensural Period
NRPN 1403	LFO 1 Symmetry
NRPN 1404	LFO 1 Start Phase
NRPN 1405	LFO 1 Mono
NRPN 1406	LFO 1 Rate
NRPN 1407	LFO 1 Delay
NRPN 1408	LFO 1 Ramp Time
NRPN 1420	LFO 2 Waveform
NRPN 1421	LFO 2 Sync Mode
NRPN 1422	LFO 2 Mensural Period
NRPN 1423	LFO 2 Symmetry
NRPN 1424	LFO 2 Start Phase
NRPN 1425	LFO 2 Mono
NRPN 1426	LFO 2 Rate
NRPN 1427	LFO 2 Delay
NRPN 1428	LFO 2 Ramp Time
NRPN 1440	LFO 3 Waveform
NRPN 1441	LFO 3 Sync Mode
NRPN 1442	LFO 3 Mensural Period
NRPN 1443	LFO 3 Symmetry
NRPN 1444	LFO 3 Start Phase
NRPN 1445	LFO 3 Mono
NRPN 1446	LFO 3 Rate
NRPN 1447	LFO 3 Delay
NRPN 1448	LFO 3 Ramp Time
NRPN 1460	LFO 4 Waveform
NRPN 1461	LFO 4 Sync Mode
NRPN 1462	LFO 4 Mensural Period
NRPN 1463	LFO 4 Symmetry
NRPN 1464	LFO 4 Start Phase
NRPN 1465	LFO 4 Mono
NRPN 1466	LFO 4 Rate
NRPN 1467	LFO 4 Delay
NRPN 1468	LFO 4 Ramp Time
NRPN 1480	LFO 5 Waveform
NRPN 1481	LFO 5 Sync Mode

NRPN 1482	LFO 5 Mensural Period
NRPN 1483	LFO 5 Symmetry
NRPN 1484	LFO 5 Start Phase
NRPN 1485	LFO 5 Mono
NRPN 1486	LFO 5 Rate
NRPN 1487	LFO 5 Delay
NRPN 1488	LFO 5 Ramp Time
NRPN 1500	LFO 6 Waveform
NRPN 1501	LFO 6 Sync Mode
NRPN 1502	LFO 6 Mensural Period
NRPN 1503	LFO 6 Symmetry
NRPN 1504	LFO 6 Start Phase
NRPN 1505	LFO 6 Mono
NRPN 1506	LFO 6 Rate
NRPN 1507	LFO 6 Delay
NRPN 1508	LFO 6 Ramp Time
NRPN 1600	Ramp 1
NRPN 1610	Ramp 2
NRPN 1620	Ramp 3
NRPN 1630	Ramp 4
NRPN 1640	Ramp 5
NRPN 1650	Ramp 6
NRPN 1660	Ramp 7
NRPN 1670	Ramp 8
NRPN 1700	Mod 1 Source
NRPN 1701	Mod 1 Shaper
NRPN 1702	Mod 1 Source Controller
NRPN 1703	Mod 1 Shaper Controller
NRPN 1710	Mod 2 Source
NRPN 1711	Mod 2 Shaper
NRPN 1712	Mod 2 Source Controller
NRPN 1713	Mod 2 Shaper Controller
NRPN 1720	Mod 3 Source
NRPN 1721	Mod 3 Shaper
NRPN 1722	Mod 3 Source Controller
NRPN 1723	Mod 3 Shaper Controller
NRPN 1730	Mod 4 Source
NRPN 1731	Mod 4 Shaper
NRPN 1732	Mod 4 Source Controller
NRPN 1733	Mod 4 Shaper Controller
NRPN 1740	Mod 5 Source
NRPN 1741	Mod 5 Shaper
NRPN 1742	Mod 5 Source Controller
NRPN 1743	Mod 5 Shaper Controller
NRPN 1750	Mod 6 Source
NRPN 1751	Mod 6 Shaper
NRPN 1752	Mod 6 Source Controller
NRPN 1753	Mod 6 Shaper Controller
NRPN 1760	Mod 7 Source

NRPN 1761	Mod 7 Shaper
NRPN 1762	Mod 7 Source Controller
NRPN 1763	Mod 7 Shaper Controller
NRPN 1770	Mod 8 Source
NRPN 1771	Mod 8 Shaper
NRPN 1772	Mod 8 Source Controller
NRPN 1773	Mod 8 Shaper Controller
NRPN 1780	Mod 9 Source
NRPN 1781	Mod 9 Shaper
NRPN 1782	Mod 9 Source Controller
NRPN 1783	Mod 9 Shaper Controller
NRPN 1790	Mod 10 Source
NRPN 1791	Mod 10 Shaper
NRPN 1792	Mod 10 Source Controller
NRPN 1793	Mod 10 Shaper Controller
NRPN 1800	Mod 11 Source
NRPN 1801	Mod 11 Shaper
NRPN 1802	Mod 11 Source Controller
NRPN 1803	Mod 11 Shaper Controller
NRPN 1810	Mod 12 Source
NRPN 1811	Mod 12 Shaper
NRPN 1812	Mod 12 Source Controller
NRPN 1813	Mod 12 Shaper Controller
NRPN 1820	Mod 13 Source
NRPN 1821	Mod 13 Shaper
NRPN 1822	Mod 13 Source Controller
NRPN 1823	Mod 13 Shaper Controller
NRPN 1830	Mod 14 Source
NRPN 1831	Mod 14 Shaper
NRPN 1832	Mod 14 Source Controller
NRPN 1833	Mod 14 Shaper Controller
NRPN 1840	Mod 15 Source
NRPN 1841	Mod 15 Shaper
NRPN 1842	Mod 15 Source Controller
NRPN 1843	Mod 15 Shaper Controller
NRPN 1850	Mod 16 Source
NRPN 1851	Mod 16 Shaper
NRPN 1852	Mod 16 Source Controller
NRPN 1853	Mod 16 Shaper Controller
NRPN 1900	Effect 1 Enable
NRPN 1901	Chorus Rate
NRPN 1902	Chorus Delay
NRPN 1903	Chorus Depth
NRPN 1904	Chorus Mix
NRPN 1905	Effect 2 Enable
NRPN 1906	Delay Left Delay Time
NRPN 1907	Delay Right Delay Time
NRPN 1908	Delay Feedback
NRPN 1909	Delay Filter Mode

NRPN 1910	Delay Resonance
NRPN 1911	Delay Left Freq
NRPN 1912	Delay Right Freq
NRPN 1913	Delay Mix
NRPN 1914	Delay Left Mensural Time
NRPN 1915	Delay Right Mensural Time
NRPN 1916	Delay Mensural Mode
NRPN 1917	Effect 1 Mode
NRPN 1918	Effect 2 Mode
NRPN 1919	Flanger Rate
NRPN 1920	Flanger Depth
NRPN 1921	Flanger Feedback
NRPN 1922	Flanger Mix
NRPN 1923	Phaser Rate
NRPN 1924	Phaser Depth
NRPN 1925	Phaser Width
NRPN 1926	Phaser Mix
NRPN 1927	Pattern Gate Enable
NRPN 1928	Pattern Gate Depth
NRPN 1929	Pattern Gate Speed
NRPN 1930	Pattern Gate Swing
NRPN 1931	Pattern Gate Length
NRPN 1932	Pattern Gate Pattern
NRPN 1933	Pattern Gate Attack
NRPN 1934	Pattern Gate Sustain
NRPN 1935	Pattern Gate Decay
NRPN 1936	Reverb Cut Freq
NRPN 1937	Reverb Time
NRPN 1938	Reverb Spread
NRPN 1939	Reverb Mix
NRPN 1940	Effects Layout

## A

- a/b 21
- About MX4
  - Version number 59
- Analog mode 26
- Arpeggiator 41
- Attack 17
- Audio input 46
- Author 23
- Automation 38

## B

- Backup copies of files 58
- Bandwidth
  - conserving 56
- Banks 21
  - creating new 23
  - deleting 23
  - exporting 23
  - importing 23
  - menu 9, 21
  - renaming 23
- Bend
  - mode 24
  - parameters 24
  - range 24
- Bipolar sources 38
- Block diagram 50
- BP (band pass) 31
- BR (band reject) 31
- Buffer size (see Hardware buffer size)

## C

- Chorus 47
- Comparing (a/b) 21
- Constant beat frequency 24
- Constant Pitch Ratio 24
- Constant portamento time 25
- Constant portamento time per octave 25
- Contextual menus 14
- Copy this item to all others 51
- Copy this setting and modulations to all others 52
- Copy this setting to all others 52
- Copyright 23
- CPR 24
- CPU
  - conserving resources 56
- Customer support 58
- Cut Frequency (reverb) 49
- Cutoff frequency 32

## D

- DADSHR 33
- Delay 48
  - feedback 48
  - filter 49
  - mix 49
- Delay (LFO) 35
- Depth
  - Flanger 47
  - Phaser 48
- Depth (gate) 41

- Destination section (File window) 22
- Detune 24
- Digital
  - Rectangle 28
  - Sawtooth 28
- Digital Performer
  - opening MX4 11
- Digital Wavetables 28
- Direction (arpeggiator) 42
- Disable all modulation sources 51
- Disable the current modulation source 14, 51
- Disclosure buttons 20
- Disks
  - keeping enough free space 58
- Distortion 31, 32
- Drive 32
- Duration (arpeggiator) 42

## E

- Effects 47
  - chorus 47
  - conserving bandwidth 56
  - delay 48
  - enable button 47
  - example 18
  - Flanger 47
  - opening effects section 18
  - Phaser 48
  - Reverb 49
- Enable (effect) 47
- Enable the current modulation source 51
- Envelope Follower 38, 43
- Envelopes 33
  - attack 17
  - conserving polyphony 56
  - modulating with 15
  - trigger mode 34
- Error messages 57
- Errors
  - file 57
  - system 57, 59
- External audio input 46
- External trigger mode 34

## F

- Fade (LFO) 35
- FAQs 55
- Feedback 48
  - Flanger 47
- File button 9, 22
- Files
  - errors 57
- Filter (delay) 49
- Filters 31
  - attack 17
  - conserving bandwidth 56
  - cutoff frequency 17, 32
  - distortion 31, 32
  - enabling 16
  - frequency modulation 32
  - low pass 16
  - mix 18, 32

- resonance 32
- topology 31
- topology menu 16
- types 31

- Fine Tuning 25
- Flanger 47
- FM 30
- Forget controller mapping 52
- Free-running phase 35
- Frequency
  - filter cutoff 32
- Frequency modulation 30, 32
- Fundamental 46
  - example of using 18

## G

- Gate and Effects topology 40
- Global randomize 52

## H

- Hardware buffer size 56
- Held 24
- Hold 33
- Hold light (arpeggiator) 42
- HP (high pass) 31

## I

- I/O buffer size (see Hardware buffer size)
- Invert all modulation ranges 52
- Invert current modulation range 52
- Invert shaper 44
- Inverting modulation 38

## K

- Key follow
  - filter 32
- Keyboard shortcuts 51
- Keyfollow 29
- Keywords 23

## L

- Lag Processor shaper 45
- LCD 9, 26
  - red numbers 16
- Learn controller mapping 52
- Legato mode 23
- Legend 50
- Level 31
- LFO 34
  - free-running phase 35
  - modulating symmetry with 14
  - polyphonic retriggering 36
  - randomizing phase 35
  - sync 36
- LP (low pass) 16, 31

## M

- Main button 9, 22
- Master section 23
- MIDI
  - activity light 9, 23
  - status light 9
- MIDI Monitor window 57
- Mix (delay) 49

- Mix (filters) 32
- Mix (reverb) 49
- Mixer 46
- Modifier keys 50
- Mods 40-45
- Mods button 9, 22
- Modulation 36
  - inverting 38
  - meter 39
  - multiple sources 16
  - oscillator settings 31
  - symmetry with LFO 14
  - wavetable with envelope 15

- Mono mode 23
- Mono retrigger mode 34
- Mono trigger mode 34
- MX4
  - expanding the window 20
  - overview 5-8, 53-54
  - tutorial 13-18
  - window 19-52
    - collapsing 9

## O

- Optimizing performance 56
- Oscillator 26
  - enabling 13
  - fine-tune 13
  - frequency modulation 30
  - level 31
  - pan 31
  - pitch 13, 30
  - symmetry 14, 30
  - sync 29
  - waveforms 27
- Out of range 48

## P

- Pan 31, 46
- Parameters
  - displaying 9, 26
  - modulating 14, 15
  - returning to zero 13
- Patch menu 21
- Patches 21
  - explained 21
  - managing 22
  - naming 23
  - reverting 21
  - saving 21
  - selecting 9
- Pattern Gate 41
- Pattern Sequencer 38, 42
- Phase (LFO) 35
- Phaser 48
- Pink noise 28
- Pitch 30
- Poly mode 23
- Poly release trigger mode 34
- Poly trigger mode 34
- Polyphonic LFO retriggering 36
- Polyphony 23, 56
  - display of used 9, 26

- Portamento 25
- Presets 21
  - Banks 9
  - comparing (a/b) 9, 21
  - explained 21
  - managing 22
  - naming 23
  - reverting 21
  - saving 9, 21
  - selecting 9
- Pulse Shape 41
- Pulse width 28
- Pulse width modulation 14

## Q

- Quantizer shaper 44

## R

- Ramps 38
- Random button 22
- Randomize base and modulations 52
- Randomize base value 52
- Randomize base values 51
- Randomize base values and modulation values 51
- Randomizing 49
  - button 9
  - LFO phase 35
  - tips 49
- Range (arpeggiator) 42
- Rate
  - Flanger 47
  - Phaser 48
- Rate (LFO) 35
- Rectangle wave 15, 28
- Red numbers 16
- Resonance 32
- Reverb 49
- Revert (presets) 21
- Ring Modulation 46

## S

- Sample and Hold shaper 45
- Save (presets) 21
- Sawtooth wave 27
- Self-modulation 37
- Sequenced trigger mode 34
- Set the modulation range for quantizing 52
- Shapers 39
- Shortcuts 51
- Signal path 26, 50
- Sine wave 27
- Source 14, 36
  - bipolar 38
  - on velocity 17
- Source section (File window) 22
- Spread (reverb) 49
- Square wave 14, 28
- Status LCD 9, 26
  - red numbers 16
- Stereo Detune 25
- Stereo mode 46
  - conserving bandwidth 56
- Swap current modulation 17

- Swap current modulation range 51
- Swing parameter 41
- Symmetry 14, 30
  - LFO 35, 36
  - modulating 14
- Sync
  - delay 48
  - LFOs 36
  - light (blinking) 48
  - oscillator 29
  - out of range 48
- System
  - troubleshooting 57
- System errors 57, 59

## T

- Technical support 58
- Time (reverb) 49
- Topology 31
  - menu 16
- Transform shaper 44
- Transpose 25
- Triangle wave 27
- Trigger mode 34
- Trigger Sequencer 45
- Troubleshooting 55, 57
  - disk errors 58
  - error messages 57, 59
  - file errors 57
  - MIDI status light 9
  - system errors 57, 59
- Tutorial 13-18

## U

- Unison Multiplier 24, 25
  - CPU bandwidth requirements 56
- Until note off 34

## V

- Vel>Volume (Velocity Sensitivity) 25
- Velocity sensitivity 25
- Voices
  - display of used 9, 26
  - setting the maximum number of 23
- Volume 25

## W

- Waveforms 27
- Wavetables 15, 28
  - index 30
- White noise 28
- Width
  - Phaser 48